

**2023 American Society for Biochemistry and  
Molecular Biology Annual Meeting (ASBMB)**

March 25 – 28, 2023  
Seattle Convention Center  
Seattle, WA

Dear Exhibitor:

As the Official General Service Contractor, we would like to welcome you to the **2023 American Society for Biochemistry and Molecular Biology Annual Meeting (ASBMB)**.

We have, along with Show Management, compiled this Exhibitor Services Manual to provide you with all of the necessary forms and vital information that you will need for a successful exposition experience.

In order to qualify for discount prices where available, please take time to review this manual now. To receive the discount prices your order(s) along with full payment must be received by the date indicated on the particular form. Please do not miss out on this opportunity to secure discounted prices. The savings offered to you are substantial.

Should you have any questions regarding any of the services or need assistance in planning your exhibit, please do not hesitate to contact our customer service department at 253 437 0031 or via email at [operations@levyexpo.com](mailto:operations@levyexpo.com). We will be happy to assist you in any way possible to ensure that you have a successful experience at **2023 American Society for Biochemistry and Molecular Biology Annual Meeting (ASBMB)**.

Thank you and we look forward to servicing your needs at **2023 American Society for Biochemistry and Molecular Biology Annual Meeting (ASBMB)** in **Seattle, Washington**.

Sincerely,

Levy Exposition Services, Inc.



## 2023 American Society for Biochemistry and Molecular Biology Annual Meeting (ASBMB)

<b>SERVICE CONTRACTOR CONTACT:</b>	LEVY EXPOSITION SERVICES INC. 14900 Interurban Ave. S, Suite 271 Seattle, WA 98168 Tel: 253 437 0031 Fax: 253 437 0032
<b>LOCATION:</b>	Seattle Convention Center 705 Pike Street Seattle, WA 98101
<b>EXHIBITOR MOVE-IN:</b>	Friday, March 24, 2023 8:00 am – 4:30 pm Saturday, March 25, 2023 8:00 am – 2:00 pm
<b>EXHIBITION DATES:</b>	Saturday, March 25, 2023 6:00 pm – 8:00 pm Sunday, March 26, 2023 12:00 pm – 6:30 pm Monday, March 27, 2023 12:00 pm – 6:30 pm Tuesday, March 28, 2023 12:00 pm – 5:30 pm
<b>EXHIBITOR MOVE-OUT:</b>	Tuesday, March 28, 2023 5:30 pm – 10:00 pm Wednesday, March 29, 2023 8:00 am – 12:00 pm <b>**please note all exhibit materials must be removed from the facility by 12:00 pm on Wednesday, March 29, 2023.**</b>
<b>BOOTH EQUIPMENT:</b>	Each 10' x 10' booth space includes: <ul style="list-style-type: none"><li>• 8' high drapery backwall – blue</li><li>• 3' high drapery sidewall - blue</li><li>• 1 – 7" x 44" booth identification sign</li></ul>
<b>BOOTH CARPET:</b>	In order to maintain a consistent and professional appearance on the show floor, ASBMB show rules <b>require</b> that all exhibitor booths have carpeting or an alternative floor covering. If you are not bringing your own carpeting or floor covering, please see the Levy Carpet Order Forms for options and ordering
<b>CEILING HEIGHT:</b>	The ceiling height in the exhibit hall is 24 feet.
<b>AISLE CARPET:</b>	The aisles will be carpeted in bluejay.
<b>DISCOUNT PRICE DEADLINE:</b>	In order to receive the discount rates listed on the enclosed order forms, your <b>PAID</b> order is to be received by <b>March 3, 2023</b> .
<b>LEVY ONLINE ORDERING:</b>	The online ordering link and instructions will be sent via email to all exhibitors. Please provide your correct contact information to the show organizer to ensure you receive all necessary show information.

# QUICK FACTS

Quick Facts continued...



## 2023 American Society for Biochemistry and Molecular Biology Annual Meeting (ASBMB)

QUICK FACTS

### SHIPMENTS:

Please see the Material Handling order form and invoice in this manual for further information and associated costs. Please note concerning outbound shipments at the close of the show, all carriers must be Checked in by 3:00 pm on Wednesday, March 29, 2023. If your carrier is not checked in by this time the shipment(s) will be re-routed via the official show carrier, Liberty Convention Freight.

### SHIPMENTS:

All **ADVANCE** air and ground shipments should arrive at the advance warehouse between February 17, 2023 – March 17, 2023 and should be consigned as follows:

ASBMB  
Company Name & Booth #  
Levy Exposition Services, Inc.  
c/o Liberty CFS NV, Inc.  
12855 48<sup>th</sup> Ave S  
Tukwila, WA 98168

All **DIRECT** air and ground shipments should not arrive prior to 8:00 AM on Friday, March 24, 2023 and should be consigned as follows:

ASBMB  
Company Name & Booth #  
Seattle Convention Center  
c/o Levy Exposition Services, Inc.  
705 Pike Street  
Seattle, WA 98101

### DISMANTLE AND MOVE-OUT INFORMATION:

All exhibitor materials **MUST** be removed from the exhibit facility by 12:00 pm on Wednesday, March 29, 2023. To ensure that all exhibitor materials are removed by this time, please have your carrier check in no later than 10:00 am on March 29, 2023.

### POST SHOW SHIPPING PAPERWORK:

Our customer service center, which will be located in the exhibit hall, will have outbound bills of lading and shipping labels for your convenience. Please note that Levy Exposition Services bills of lading **MUST** be filled out and turned into the service center once your materials are packed for all outbound shipments. It is vital that your carrier knows your company name and booth # when you make your outbound shipping arrangements. Additionally, if your carrier plans to use a freight forwarder company to pick up your shipment(s), you **MUST** include this company's name as well as the actual shipping company's name on the bill of lading that you fill out. In the event someone other than the company listed on your outbound bill of lading arrives to pick up your shipment, it will be rerouted via the official show carrier.

## SAFETY RULES

Exhibitors must provide adequate space within the exhibit to allow for the comfort and safety of persons watching demonstrations and/or placing orders. Each exhibitor is responsible for keeping the aisles near their booth free of congestion which may be caused by such demonstrations and/or order placement.

Aisles **MUST** remain free and clear of all obstructions. If chairs are being used as part of your exhibit, they **MUST** remain inside your booth space. Chairs in the aisle constitute a violation of fire codes and are also considered a booth violation.

Do not run electrical cords or position displays and/or product in such a way as to pose a safety hazard for attendees and company personnel who will traffic into booth areas.

Do not store cardboard cartons or packing materials in booth areas, as this is a violation of fire codes and poses a safety hazard.

Do not place product samples, whether on tables or free-standing displays, at the edge of the aisle, or in the case of an island booth, on shelving units on an outside wall. All portions of an Exhibitor's display must be contained within his/her assigned booth space, including chairs placed at the edge of an aisle.

At the close of the exhibit hall, please keep clear of all aisles including exhibit material and/or product. During the first two or three hours after the close of the exhibit hall, there is ample traffic in the aisles including but not limited to forklift traffic returning empty containers.

# UNION REGULATIONS

---

## SEATTLE, WASHINGTON UNION JURISDICTIONS

To assist you in planning for your participation in this event, we're certain that you will appreciate knowing in advance that union labor may be required for certain aspects of your exhibit handling and erection. To help you understand the jurisdictions that the local unions have, we ask that you please read the following:

## EXHIBIT INSTALLATION AND DISMANTLING

We currently have an agreement with the local Carpenters Union to provide labor for display installation and dismantling. Full time employees of the exhibiting companies, however, may install and dismantle their own exhibits without assistance from the Carpenters Union as long as the exhibit can be installed and dismantled utilizing Full time company employees without the use of power tools or ladders and is 200 square feet or less in size. Labor required in excess of this must be ordered thru Levy Exposition Services. It is recommended that all display labor required be ordered in advance from the Levy Exposition Services Labor Order Form located in your exhibitor service manual. Proof of full time employment status must be carried at all times.

## MATERIAL HANDLING

Exhibitors may hand-carry their own materials into and out of the exhibit facility. The use or rental of dollies, flat carts and other mechanical equipment is not permitted. Levy Exposition Services will control access to the loading docks in order to provide for a safe and orderly move in/out. Only full time employees of the exhibiting companies will be permitted to hand-carry items into and out of the exhibit facility. Unloading or reloading at the dock of any and all contracted carriers will be handled exclusively by Levy Exposition Services.

## TIPPING

Levy Exposition Services requests that exhibitors refrain from tipping our employees. They are paid at an excellent wage scale denoting a professional status and we feel that tipping is not necessary. Any request for a tip made by any employee of Levy Exposition Services should be brought to the attention of a Levy Exposition Services representative at the exhibitor service desk. We thank you in advance for your cooperation in this matter.

## SAFETY

Standing on tables, chairs or other rental furniture is strictly prohibited. Our furniture rental items are not engineered to support your standing weight. Levy Exposition Services cannot and will not be held responsible for injuries or falls caused by improper use of this furniture. If assistance is required in assembling or dismantling your exhibit, please order labor on the Labor Order Form and the necessary tools and ladders will be provided.

LABOR & CONDITIONS

## EXHIBIT CONSTRUCTION GUIDELINES SUMMARY

The Exhibitor's responsibility can be summed up as simply: **"Be a good neighbor!"** All exhibitors are equal regardless of size and should be given an equal opportunity, within reason, to present their product in the most effective manner to the audience.

### STANDARD BOOTH

Linear Booths have only one side exposed to an aisle and are generally arranged in a series along a straight line. They are also called "in-line" booths.

**Dimensions:** Linear Booths are most commonly ten feet (10') wide and ten feet (10') deep, i.e. 10'x10'. A maximum back wall height limitation of height feet (8') is generally specified.

**Use of Space:** Regardless of the number of Linear Booths utilized, (e.g. 10'x20', 10'x30', 10'x40', etc.) Display materials should be arranged in such a manner so as not to obstruct sight lines of neighboring exhibitors.

The maximum height of eight feet (8') is allowed only in the rear half of the booth space, with a four-foot (4') height restriction imposed on all materials in the remaining space forward to the aisle.

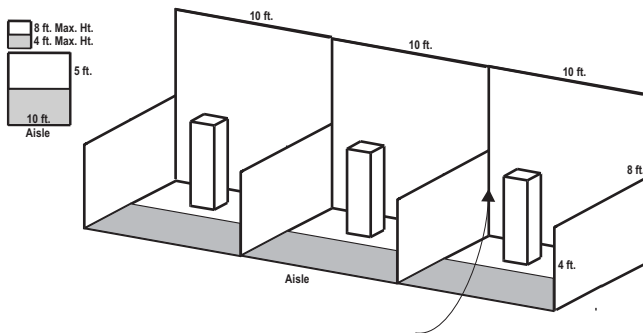

One or more standard 10'x10' units in a straight line.

**Note:** Booth drape is set at 8 ft max.

Display fixtures over 4 ft high must be confined to that area that is at least 5 ft from the aisle line.

### ISLAND BOOTH

An Island Booth is any size booth exposed to aisles on all four sides.

**Dimensions:** An Island Booth is 20' x 20' or larger, although it may be configured differently.

**Use of Space:** The entire cubic content of the space may be used up to the maximum allowable height, which is usually twenty feet (20'), including signage.

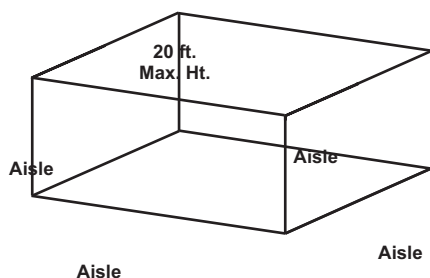

**Please note that the ceiling height in the Exhibit Hall is 24 feet.**

### HANGING SIGN BOOTH

An exhibit component suspended above an exhibit of four or more standard units back-to-back with an aisle on at least three sides for the purpose of displaying graphics or identification.

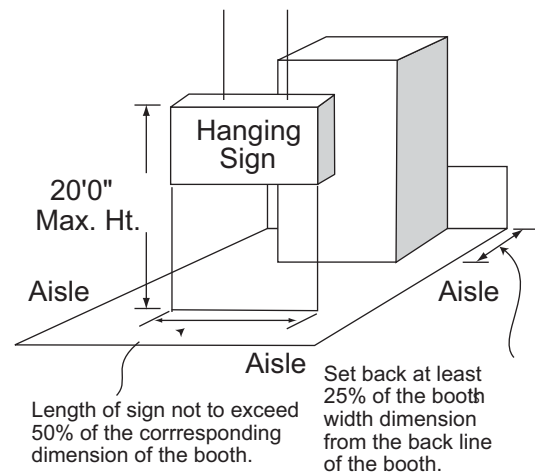

**\*\*All overhead hanging must be assembled, installed, and removed by Levy. Please complete the enclosed Labor Order Form for labor to assemble your hanging sign.\*\***



**Fax: 253 437 0032**  
 14900 Interurban Avenue South, Suite 271  
 Seattle, WA  
 USA 98168  
 Telephone: 253 437 0031  
 E-mail: operations@levyexpo.com

**2023 American Society for Biochemistry and  
 Molecular Biology Annual Meeting (ASBMB)**  
 March 25 - 28, 2023  
 Seattle Convention Center  
 Seattle, WA

## THIRD PARTY BILLING REQUEST

COMPANY	BOOTH NUMBER	<b>Deadline Date March 3, 2023</b>
ADDRESS <small>street city state/province zip/postal code country</small>		
PHONE <small>FAX</small>	PURCHASE ORDER NUMBER	<i>All orders are regulated by LES Payment Terms &amp; Conditions as well as Material Handling Terms &amp; Conditions.</i>
AUTHORIZED CONTACT SIGNATURE <b>X</b>	AUTHORIZED CONTACT - PLEASE PRINT DATE	

**You may arrange for a third party** to handle your display and be billed for services. LES will agree to this arrangement if the third party has a satisfactory payment record with us. BOTH firms must complete this form, and the **THIRD PARTY must complete the credit card charge authorization on the *Payment & Credit Card Authorization form***. Return both forms by the deadline date.

**It is understood and agreed that the exhibiting firm** is ultimately responsible for payment of charges. If your named third party does not pay the invoice before the last day of the show, charges will revert to you, the exhibiting firm. All invoices are due and payable upon receipt.

### EXHIBITING FIRM

EXHIBITING FIRM \_\_\_\_\_

ADDRESS \_\_\_\_\_

CITY STATE/PROVINCE ZIP/POSTAL CODE \_\_\_\_\_

PHONE FAX \_\_\_\_\_

AUTHORIZED SIGNATURE \_\_\_\_\_

### THIRD PARTY

THIRD PARTY \_\_\_\_\_

ADDRESS \_\_\_\_\_

CITY STATE/PROVINCE ZIP/POSTAL CODE \_\_\_\_\_

PHONE FAX \_\_\_\_\_

AUTHORIZED SIGNATURE \_\_\_\_\_

**ALL LES SERVICES WILL BE INVOICED TO THE THIRD PARTY UNLESS INDICATED BELOW:**

\_\_\_\_\_

\_\_\_\_\_

### EXHIBITING FIRM'S CREDIT CARD CHARGE AUTHORIZATION

CARDHOLDER'S BILLING ADDRESS

CITY PROV. / STATE \_\_\_\_\_

POSTAL/ZIP CODE COUNTRY \_\_\_\_\_

TODAY'S DATE MONTH / DAY / YEAR

CARD NUMBER

VISA  MASTERCARD  AMEX  CHECK

EXPIRY DATE     CVCC

CARDHOLDER NAME  
(PLEASE PRINT)

SIGNATURE \_\_\_\_\_



**Fax: 253 437 0032**  
 14900 Interurban Avenue South, Suite 271  
 Seattle, WA  
 USA 98168  
 Telephone: 253 437 0031  
 E-mail: operations@levyexpo.com

**2023 American Society for Biochemistry and  
 Molecular Biology Annual Meeting (ASBMB)**  
 March 25 - 28, 2023  
 Seattle Convention Center  
 Seattle, WA

## PAYMENT & CREDIT CARD CHARGE AUTHORIZATION FORM

COMPANY				BOOTH NUMBER		<b>All orders are regulated by LES Payment Terms &amp; Conditions as well as Material Handling Terms &amp; Conditions.</b>	
ADDRESS		street	city	state/province	zip/postal code		country
PHONE	FAX	PO #	E-MAIL				
AUTHORIZED CONTACT SIGNATURE <b>X</b>			AUTHORIZED CONTACT - PLEASE PRINT		DATE		

### CREDIT CARD AUTHORIZATION

<input type="checkbox"/> VISA		<input type="checkbox"/> MASTERCARD		<input type="checkbox"/> AMERICAN EXPRESS		EXPIRY DATE			CCVC				
ACCOUNT NUMBER													<input type="checkbox"/> CORPORATE <input type="checkbox"/> PERSONAL
CARDHOLDER'S BILLING ADDRESS				city	state/province	zip/postal code	country						
CARDHOLDER'S SIGNATURE <b>X</b>				CARDHOLDER'S NAME - PLEASE PRINT									

**Please complete the REQUIRED order forms and submit with Payment & Credit Card Authorization Form and full payment.** You may choose to pay by credit card and/or bank check, however, **we require your credit card authorization to be on file with LES.** For your convenience, we will use this authorization to charge your credit card for any additional amounts incurred as a result of show site orders placed by your representative for this event.

### CALCULATION OF ORDER FORMS

TOTAL FROM EACH ORDER FORM

Carpet, Drape & Complements Rental Order Form.....	\$	
Custom Carpet Order Form.....	\$	
Table and Chair Rental Order Form.....	\$	
Specialty Accessories Order Form.....	\$	
Rental Exhibits Order Form.....	\$	
Cabinets Order Form.....	\$	
Graphics & Sign Order Form.....	\$	
Plant & Flower Order Form.....	\$	
Exhibit Booth Cleaning Order Form.....	\$	
In-Booth Forklift Order Form.....	\$	
Sign & Banner Hanging Order Form.....	\$	
Labor Order Form.....	\$	
Material Handling Order Form.....	\$	
<b>FULL PAYMENT IN US FUNDS</b>	<b>\$</b>	

**To simplify payment, send one check payable to Levy Exposition Services Inc. for the entire amount or note the amount to be charged to your credit card.**

Charge my credit card in the amount of \$

Check no.  Dated  in the amount of \$



# CARPET and DRAPE

## Standard carpet color options



Blue

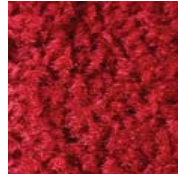

Red

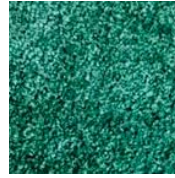

Teal



Grey



Burgundy



Purple

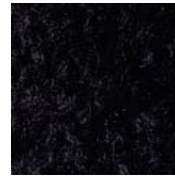

Black

## Drape color options

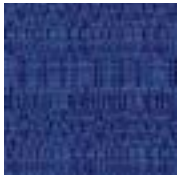

Blue



Red

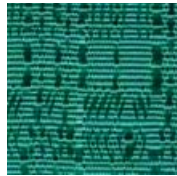

Teal



White

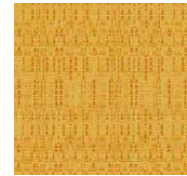

Gold



Black



Purple

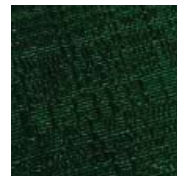

Green

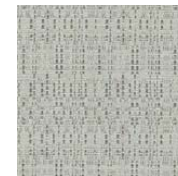

Grey



Burgundy

*\*DISCLAIMER\* Actual products and colors available may vary from the images shown. All products subject to availability*

Do you have questions?

We would be pleased to help. Contact us at: 253 437 0031

[operations@levyexpo.com](mailto:operations@levyexpo.com)

[www.levyexpo.com](http://www.levyexpo.com)

## CARPET, DRAPE & COMPLEMENTS RENTAL ORDER FORM & INVOICE

### COLORED CARPET SELECTIONS

Description	Discount Rate	Standard Rate	Total
Size - 10 ft. X 10 ft.	357.00	464.10	
10 ft. X 20 ft.	592.00	769.60	
10 ft. X 30 ft.	888.00	1154.40	
10 ft. X 40 ft.	1,184.00	1,539.20	
Custom cut size. Calculate sq. ft. x price per sq. ft.  Size _____ ft. x _____ ft. = _____ sq. ft.	4.95	6.44	

Blue  Red  Teal  Grey  Burgundy  Purple  Black

### DRAPE (Includes installation and removal)

_____ lin. ft. of 3' high drape	\$8.75/ft	\$11.35/ft	
_____ lin. ft. of 8' high drape	\$11.05/ft	\$14.73/ft	

Blue  Red  Teal  White  Gold  Black  
 Purple  Green  Grey  Burgundy

### CARPET OPTIONS

Description	Discount Rate	Standard Rate	Total
Carpet foam padding per sq. ft. Size _____ ft. x _____ ft. = _____ sq. ft.	2.30	2.99	
Poly covering per sq. ft. Size _____ ft. x _____ ft. = _____ sq. ft.	1.20	1.56	

### COMPLEMENTS (Also see Specialty Accessories Form)

Quantity	Description	Discount Rate	Standard Rate	Total
	Waste basket	27.00	35.10	
	Chrome coat tree	98.00	128.00	
	Aluminum easel	75.00	97.50	
	Chrome sign holder 22" X 28"	199.00	258.70	
	Chrome stanchions	35.00	45.50	
	Velvet stanchion ropes - blue	35.00	45.50	

### SPECIAL INSTRUCTIONS

---

---

---

---

---

---

---

---

### EXHIBITOR INFORMATION

COMPANY \_\_\_\_\_

CONTACT \_\_\_\_\_

**BOOTH#**

### COST SUMMARY

RATE ADJUSTMENT	(OFFICE USE ONLY)	
25% CANCELLATION FEE	(OFFICE USE ONLY)	
SUBTOTAL		
10.25% SALES TAX		
<b>TOTAL</b>	<b>US DOLLARS</b>	

**PLEASE REFER TO THE PAYMENT & CREDIT CARD CHARGE AUTHORIZATION FORM**

\*\*ORDERS WILL NOT BE PROCESSED WITHOUT PAYMENT\*\*

**STANDARD RATE** will be applied to all orders not received and paid in full by **March 3, 2023**. We reserve the right to adjust orders calculated incorrectly.

**A 25% CANCELLATION FEE** will be applied to all orders received and then canceled. If full service has been provided then 100% of original fee will be applied.

# CUSTOM CARPET

## Deluxe Decorator 28oz. Carpet color options



Black



Red



Nu Blue



Silver Cloud



Beige



Charcoal



Key Lime

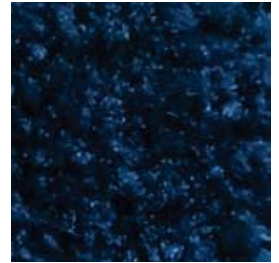

Navy



Cobalt



White

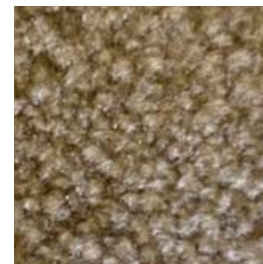

Silky Beige

*\*DISCLAIMER\* Actual products and colors available may vary from the images shown. All products subject to availability*

Do you have questions?

We would be pleased to help. Contact us at: 253 437 0031

[operations@levyexpo.com](mailto:operations@levyexpo.com)

[www.levyexpo.com](http://www.levyexpo.com)

**CUSTOM CARPET ORDER FORM**

**Deluxe 28 oz. Carpet in a Variety of Decorator Colors to Enhance Your Exhibit**

- |                                       |                                      |                                   |
|---------------------------------------|--------------------------------------|-----------------------------------|
| <input type="checkbox"/> Black        | <input type="checkbox"/> Red         | <input type="checkbox"/> Nu Blue  |
| <input type="checkbox"/> Silver Cloud | <input type="checkbox"/> Beige       | <input type="checkbox"/> Charcoal |
| <input type="checkbox"/> Key Lime     | <input type="checkbox"/> Navy        | <input type="checkbox"/> Cobalt   |
| <input type="checkbox"/> White        | <input type="checkbox"/> Silky Beige |                                   |

(CHECK BOX OF COLOR DESIRED)  
 SAMPLES AVAILABLE UPON REQUEST

Rental includes installation and poly covering for protection and removal.  
 Orders must be received by **March 3, 2023** to guarantee availability.

		DISCOUNT PRICE	STANDARD PRICE (late order)
Booth Size	____ ft. x ____ ft. = _____ sq. Ft. at	\$7.10 per sq. ft.	\$9.23 per sq. ft. =\$ _____
Carpet Pad	____ ft. x ____ ft. = _____ sq. Ft. at	\$2.30 per sq. ft.	\$2.99 per sq. ft. =\$ _____

NOTE: Include a floor plan if additional carpet is required to cover steps, skids and display fixtures. A quotation will be forwarded to you before we proceed

**SPECIAL INSTRUCTIONS**

---



---



---

**EXHIBITOR INFORMATION**

COMPANY \_\_\_\_\_

CONTACT \_\_\_\_\_ **BOOTH#** \_\_\_\_\_

**COST SUMMARY**

RATE ADJUSTMENT	(OFFICE USE ONLY)	
CANCELLATION FEE	(OFFICE USE ONLY)	
SUBTOTAL		
10.25% SALES TAX		
<b>TOTAL US DOLLARS</b>		

**PLEASE REFER TO THE PAYMENT & CREDIT CARD CHARGE AUTHORIZATION FORM**  
 \*\*ORDERS WILL NOT BE PROCESSED WITHOUT PAYMENT\*\*

**STANDARD RATE** will be applied to all orders not received and paid in full by **March 3, 2023**. We reserve the right to adjust orders calculated incorrectly.

**A 25% CANCELLATION FEE** will be applied to all orders received then canceled. If full service has been provided then 100% of original fee will be applied.

# TABLES & CHAIRS

## Tables

All tables are available in the below options:

- Unskirted or Skirted
- 30" or 40" height
- 4', 6', or 8' lengths x 2' widths



4' x 2' skirted table



6' x 2' skirted table



8' x 2' skirted table

## Skirt color options



Blue



Red



Black



Teal



Burgundy



Gold

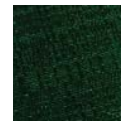

Green



Grey



Purple



White

## Pedestal Tables

All pedestal tables are available in the below options:

- 30" diameter tops
- 30" or 40" high



40" high pedestal



30" high pedestal

## Chairs



Fabric Sled Base Chair



Fabric Arm Chair



Fabric Highback Stool

*\*DISCLAIMER\* Actual products and colors available may vary from the images shown. All products subject to availability*

Do you have questions?

We would be pleased to help. Contact us at: 253 437 0031

operations@levyexpo.com

www.levyexpo.com

## TABLE AND CHAIR RENTAL ORDER FORM & INVOICE

### TABLES

Description	Qty.	Discount Rate	Standard Rate	Total
 <b>TABLES 30" HEIGHT</b>				
8' x 2' Skirted		232.75	302.58	
6' x 2' Skirted		215.00	279.50	
4' x 2' Skirted		185.00	240.50	
Fourth side of table skirted		102.00	132.60	
Unskirted table <input type="checkbox"/> 8' <input type="checkbox"/> 6' <input type="checkbox"/> 4'		129.00	167.70	
<input type="checkbox"/> Blue <input type="checkbox"/> Red <input type="checkbox"/> Black <input type="checkbox"/> Teal <input type="checkbox"/> Burgundy <input type="checkbox"/> Gold <input type="checkbox"/> Green <input type="checkbox"/> Grey <input type="checkbox"/> Purple <input type="checkbox"/> White				

 <b>TABLES 40" COUNTER HEIGHT</b>				
8' x 2' Skirted		275.00	357.50	
6' x 2' Skirted		255.00	331.50	
4' x 2' Skirted		230.00	299.00	
Fourth side of table skirted		132.00	171.60	
Unskirted table <input type="checkbox"/> 8' <input type="checkbox"/> 6' <input type="checkbox"/> 4'		142.00	184.60	
<input type="checkbox"/> Blue <input type="checkbox"/> Red <input type="checkbox"/> Black <input type="checkbox"/> Teal <input type="checkbox"/> Burgundy <input type="checkbox"/> Gold <input type="checkbox"/> Green <input type="checkbox"/> Grey <input type="checkbox"/> Purple <input type="checkbox"/> White				

 <b>GREY PEDESTAL TABLE - 30" DIAMETER</b>				
30" Table height		210.00	273.00	
40" Counter height		230.00	299.00	

### SPECIAL INSTRUCTIONS

---



---



---

### EXHIBITOR INFORMATION

COMPANY	
CONTACT	BOOTH#

### COST SUMMARY

RATE ADJUSTMENT	(OFFICE USE ONLY)	
CANCELLATION FEE	(OFFICE USE ONLY)	
SUBTOTAL		
10.25% SALES TAX		
<b>TOTAL</b>	<b>US DOLLARS</b>	

## PLEASE REFER TO THE PAYMENT & CREDIT CARD CHARGE AUTHORIZATION FORM





\*\*ORDERS WILL NOT BE PROCESSED WITHOUT PAYMENT\*\*

**STANDARD RATE** will be applied to all orders not received and paid in full by **March 3, 2023**. We reserve the right to adjust orders calculated incorrectly.

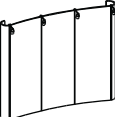

**A 25% CANCELLATION FEE** will be applied to all orders received and then canceled. If full service has been provided then 100% of original fee will be applied.

## SPECIALTY ACCESSORIES RENTAL ORDER FORM & INVOICE

### DISPLAY UNITS

Description	Qty.	Discount Rate	Standard Rate	Total
 <b>FABRIC POSTER BOARD</b> 4' x 8' grey fabric covered both sides <input type="checkbox"/> Horizontal (shown) <input type="checkbox"/> Vertical		464.00	603.20	
 <b>POP-UP BOOTH</b> 9'-6" x 7'-5" tall Velcro compatible Set of four lights <input type="checkbox"/> Blue <input type="checkbox"/> Grey <input type="checkbox"/> Black		3,240.00	4,212.00	
 <b>BLACK UPRIGHT LITERATURE RACK</b> 6 pockets for 8.5" x 11" material		267.00	347.10	
 <b>PLEXIGLASS BROCHURE HOLDER</b> 9" x 11" <input type="checkbox"/> Table top <input type="checkbox"/> Wall mount		46.00	59.80	
 <b>ALUMINUM EASEL</b> Fits sign sizes: 22" x 28" 24" x 36" 28" x 44"		75.00	97.50	
 <b>CHROME SIGN HOLDER</b> 22" x 28"		199.00	258.70	

### ACCESSORIES

 <b>CHROME BAG HOLDER OR CLOTHING STAND</b>		120.00	156.00	
 <b>CHROME COAT TREE</b>		98.00	128.00	

### SPECIAL INSTRUCTIONS

### EXHIBITOR INFORMATION

COMPANY

CONTACT

**BOOTH#**

### COST SUMMARY

RATE ADJUSTMENT	(OFFICE USE ONLY)	
25% CANCELLATION FEE	(OFFICE USE ONLY)	
SUBTOTAL		
10.25% SALES TAX		
<b>TOTAL</b>	<b>US DOLLARS</b>	

**PLEASE REFER TO THE PAYMENT & CREDIT CARD CHARGE AUTHORIZATION FORM**

**\*\*ORDERS WILL NOT BE PROCESSED WITHOUT PAYMENT\*\***

**STANDARD RATE** will be applied to all orders not received and paid in full by **March 3, 2023**. We reserve the right to adjust orders calculated incorrectly.

**A 25% CANCELLATION FEE** will be applied to all orders received and then canceled. If full service has been provided then 100% of original fee will be applied.

# RENTAL EXHIBITS

## 10' x 10' Hardwall Rental Exhibit Booths

All hardwall packages include the below:

- Aluminum structure
- White
- Header(s) - block letters - black (logo extra)
- 10' x 10' Carpet
- 30" pedestal table (x1)
- Fabric sledbase chairs (x2)

### Package A1 Base



### Package A2 Deluxe

- Base Package plus the below:
- 10" deep shelves (x2)
- 39" x 20" x 39" counter (x1)

### Package B1 Base

- Curved header - block letters - black (logo extra)
- Curved front display counter



### Package B2 Deluxe

- Base Package plus the below:
- Enclosed corner counter
- 10" deep shelves (x2)

### Package C1 Base



### Package C2 Deluxe

- Base Package plus the below:
- 10" deep shelves (x2)
- 39" x 20" x 39" counter (x1)

### Package D1 Base

- Oversized header - block letters - black (logo extra)
- 20" x 39" x 39" high built-in counters on backwall (x2)



### Package D2 Deluxe

- Base Package plus the below:
- 10" deep shelves (x2)
- 39" x 20" x 39" counter (x1)

*\*DISCLAIMER\* Actual products and colors available may vary from the images shown. All products subject to availability*

Do you have questions?

We would be pleased to help. Contact us at: 253 437 0031

operations@levyexpo.com

www.levyexpo.com



# RENTAL EXHIBITS

## 10' x 20' Hardwall Rental Exhibit Booths

All hardwall packages include the below:

- Aluminum structure
- White
- Header(s) - block letters - black (logo extra)
- 10' x 20' Carpet
- 30" pedestal table (x1)
- Fabric sledbase chairs (x2)

### Package E1 Base

- Straight headers (x2)

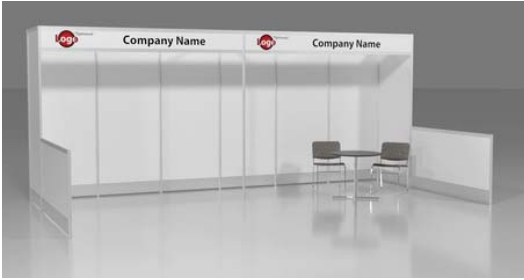

### Package E2 Deluxe

- Base Package plus the below:
- 10" deep shelves (x2)
- 39" x 20" x 39" counter (x1)



### Package F1 Base

- Straight header (x1)
- Angled header (x2)
- Storage area with drape door
- Front built-in corner counters (x2)



### Package F2 Deluxe

- Base Package plus the below:
- Lockable door for storage area
- 39" x 20" x 39" counter (x2)



### Package G1 Base

- Straight header (x1)
- 39" x 20" x 39" built-in counter (x1)



### Package G2 Deluxe

- Base Package plus the below:
- 10" deep shelves (x4)



### Package H1 Base

- Oversized curved header (x1)
- 39" x 20" x 39" built-in counters (x3)



### Package H2 Deluxe

- Base Package plus the below:
- 10" deep shelves (x3)
- 2m curved front counter (x1)



*\*DISCLAIMER\* Actual products and colors available may vary from the images shown. All products subject to availability*

Do you have questions?

We would be pleased to help. Contact us at: 253 437 0031

operations@levyexpo.com

www.levyexpo.com

# CUSTOM EXHIBITS

**A more sophisticated technique to exhibit marketing messages creatively and effectively!**

With decades of service, Levy continues to provide viable and reliable alternatives to maximize clients' overall booth space. Our sales team and design specialists work closely with each and every client to create a unique exhibit designed to meet a wide variety of today's marketing strategies. Whether the image and budget are conservative or extravagant Levy exceeds to offer the most suitable and perfect space solutions.



Collaboratively designed to meet your specific requirements, budget, and bring your vision to reality.

Each Levy Custom Designed Exhibit will be built to exact specifications and will be:

- Unique
- Attractive
- Versatile
- Impressive
- Memorable
- Functional
- Creative
- Inviting
- Efficient

**Let us help you create a one of a kind booth space.**

**Call our experienced professionals for an innovative, customized, and no obligation approach.**





Fax: 253 437 0032  
 14900 Interurban Avenue South, Suite 271  
 Seattle, WA  
 USA 98168  
 Telephone: 253 437 0031  
 E-mail: operations@levyexpo.com

2023 American Society for Biochemistry and  
 Molecular Biology Annual Meeting (ASBMB)  
 March 25 - 28, 2023  
 Seattle Convention Center  
 Seattle, WA

## RENTAL EXHIBITS RENTAL ORDER FORM & INVOICE

### 10' x 10' BOOTH PACKAGES - Please contact customer service for GRAPHIC UPGRADES

Description: Base package includes: Aluminum structure, white hardwalls, booth header with company name in block lettering, carpet, 30" pedestal table, (2) fabric chairs, installation and dismantle.	Qty	Discount Rate	Standard Rate	Total
<b>PACKAGE A1 Basic</b> - Base package with header		3,888.00	5,054.40	
<b>PACKAGE A2 Deluxe</b> - Base package + (2) 10" deep shelves, (1) 39" x 20" x 39" counter		4,418.00	5,743.40	
<b>PACKAGE B1 Basic</b> - Corner base package booth with curved counter, 1 curved header sign		4,428.00	5,756.40	
<b>PACKAGE B2 Deluxe</b> - Base package + enclosed corner counter, (2) 10" deep shelves		4,488.00	5,834.40	
<b>PACKAGE C1 Basic</b> - Base package with header		4,068.00	5,288.40	
<b>PACKAGE C2 Deluxe</b> - Base package + (2) 10" deep shelves, (1) 39" x 20" x 39" counter		4,598.00	5,977.40	
<b>PACKAGE D1 Basic</b> - Base package with oversized header, (2) built-in back counters		4,584.00	5,959.20	
<b>PACKAGE D2 Deluxe</b> - Base package + (2) 10" deep shelves, (1) 39" x 20" x 39" counter		5,114.00	6,648.20	

### 10' x 20' BOOTH PACKAGES - Please contact customer service for GRAPHIC UPGRADES

Description: Base package includes: Aluminum structure, white hardwalls, booth header with company name in block lettering, carpet, 30" pedestal table, (2) fabric chairs, installation and dismantle.	Qty	Discount Rate	Standard Rate	Total
<b>PACKAGE E1 Basic</b> - Base package with headers		5,832.00	7,581.60	
<b>PACKAGE E2 Deluxe</b> - Base package + (2) 10" deep shelves, (1) 39" x 20" x 39" counter		6,362.00	8,271.12	
<b>PACKAGE F1 Basic</b> - Base package with headers, storage and drape door, (2) built-in counters		6,252.00	8,127.60	
<b>PACKAGE F2 Deluxe</b> - Base package + lockable door for storage, (2) 39" x 20" x 39" counters		6,782.00	8,816.60	
<b>PACKAGE G1 Basic</b> - Base package with header, (1) built-in counter		6,624.00	8,611.20	
<b>PACKAGE G2 Deluxe</b> - Base package + (2) 10" deep shelves		7,154.00	9,300.20	
<b>PACKAGE H1 Basic</b> - Base package with oversized curved header, (3) built-in back counters		7,416.00	9,640.80	
<b>PACKAGE H2 Deluxe</b> - Base package + (2) 10" deep shelves, (1) curved front counter		7,946.00	10,329.80	

### OPTIONS & INFORMATION

#### HARDWALL PANEL (non fabric) SELECTION

White

#### CARPET COLOR SELECTIONS

Grey  Red  Teal  Blue  Black  Burgundy  Purple

#### HEADER TO READ (up to 20 characters, black lettering on white)

Header One

Header Two

### ACCESSORY OPTIONS

Description	Qty.	Discount Rate	Standard Rate	Total
1 meter Angled Shelves		70.00	91.00	
1 meter Shelves		59.00	76.70	
Spot Lights (For use with rental unit)		77.00	100.10	
Literature Pockets 8 1/2" x 11"		31.00	40.30	
Nylon Loop Fabric Panel per sq.ft. **contact for available color options		\$5.00 sq.ft.	6.50 sq.ft.	

### SPECIAL INSTRUCTIONS

### EXHIBITOR INFORMATION

COMPANY

CONTACT

**BOOTH#**

### COST SUMMARY

RATE ADJUSTMENT (OFFICE USE ONLY)	
25% CANCELLATION FEE (OFFICE USE ONLY)	
SUBTOTAL	
10.25% SALES TAX	
<b>TOTAL US DOLLARS</b>	

## PLEASE REFER TO THE PAYMENT & CREDIT CARD CHARGE AUTHORIZATION FORM

\*\*ORDERS WILL NOT BE PROCESSED WITHOUT PAYMENT\*\*

**STANDARD RATE** will be applied to all orders not received and paid in full by **March 3, 2023**. We reserve the right to adjust orders calculated incorrectly.

**A 25% CANCELLATION FEE** will be applied to all orders received and then cancelled 2 weeks prior to install. If full service has been provided then 100% of original fee will be applied.  
 xpo21\_rentalexhibits

# CABINETS

## Straight Cabinets

All straight cabinets come with sliding doors. Optional Upgrades noted below:

- Lock for doors
- Lighting  
\*Jewelry Case or Show Case
- Branding - graphic panels



**Cabinet "A"**

1 meter cabinet with doors  
39" long x 20" deep x 40" high



**Cabinet "B"**

1 meter Jewelry Case with doors  
39" long x 20" deep x 40" high



**Cabinet "C"**

1 meter Show Case with doors  
39" long x 20" deep x 40" high  
(2 meter Show Case available)



**Cabinet "D"**

2 meter cabinet with doors  
80" long x 20" deep x 40" high

## Curved Cabinets

Optional Upgrades noted below:

- Lock for doors
- Branding - graphic panels



**Cabinet "E"**

1 meter curved cabinet  
61" long x 20" deep x 40" high

**Cabinet "F"**

1 meter curved cabinet with door  
61" long x 20" deep x 40" high

\*\*Same as cabinet "E" but with door

\*DISCLAIMER\* Actual products and colors available may vary from the images shown. All products subject to availability

## CABINETS ORDER FORM & INVOICE

STYLE	DESCRIPTION	QTY	DISCOUNT RATE	STANDARD RATE	TOTAL
CABINET "A"	1 meter Cabinet with doors <input type="checkbox"/> Lock (\$20.00 each)		696.00	904.80	
	Cabinet with + custom graphic panel <input type="checkbox"/> Lock (\$20.00 each)		906.00	1,177.80	
CABINET "B"	1 meter Jewelry Case with doors <input type="checkbox"/> Lock (\$20.00 each) <input type="checkbox"/> Lights (\$20.00 each)		792.00	1,029.60	
	Jewelry Case + custom graphic panel <input type="checkbox"/> Lock (\$20.00 each) <input type="checkbox"/> Lights (\$20.00 each)		929.00	1,207.70	
CABINET "C"	1 meter Show Case with doors (2 meter Show Case available - call for quote) <input type="checkbox"/> Lock (\$20.00 each) <input type="checkbox"/> Lights (\$20.00 each)		912.00	1,185.60	
	Show Case + custom graphic panel <input type="checkbox"/> Lock (\$20.00 each) <input type="checkbox"/> Lights (\$20.00 each)		996.00	1,294.80	
CABINET "D"	2 meter Cabinet with doors <input type="checkbox"/> Lock (\$20.00 each)		936.00	1,216.80	
	2 meter Cabinet + custom graphic panel <input type="checkbox"/> Lock (\$20.00 each)		1,381.00	1,795.30	
CABINET "E"	1 meter Curved cabinet (open back)		804.00	1,045.20	
	Curved cabinet + custom graphic panel		1,145.00	1,489.80	
CABINET "F"	1 meter Curved cabinet with doors <input type="checkbox"/> Lock (\$20.00 each)		828.00	1,076.40	
	Curved cabinet w/ doors + custom graphic panel		1,170.00	1,521.00	

NOTE: Should you wish to have a graphic panel upgrade for your cabinet, please contact our Operations department to confirm details on graphic file submission.

### EXHIBITOR INFORMATION

COMPANY	
CONTACT	<b>BOOTH#</b>

### COST SUMMARY

RATE ADJUSTMENT	(OFFICE USE ONLY)	
CANCELLATION FEE	(OFFICE USE ONLY)	
SUBTOTAL		
10.25% SALES TAX		
<b>TOTAL US DOLLARS</b>		

## PLEASE REFER TO THE PAYMENT & CREDIT CARD CHARGE AUTHORIZATION FORM

\*\*ORDERS WILL NOT BE PROCESSED WITHOUT PAYMENT\*\*

**STANDARD RATE** will be applied to all orders not received and paid in full by **March 3, 2023**. We reserve the right to adjust orders calculated incorrectly.

**A 25% CANCELLATION FEE** will be applied to all orders received and then cancelled. If full service has been provided then 100% of original fee will be applied.

## GRAPHICS AND SIGN ORDER FORM & INVOICE

### STANDARD SIGN SIZES

Quantity	Description	Discount Rate	Standard Rate	Total
	7" x 11"	31.00	40.00	
	7" x 44"	37.00	48.00	
	11" x 14"	47.00	61.00	
	14" x 22"	63.00	82.00	
	22" x 28"	79.00	103.00	
	28" x 44"	113.00	147.00	

Prices listed are for one-color copy (up to 10 words) on a white background.

### OPTIONAL SERVICES

Quantity	Description	Discount Rate	Standard Rate	Total
	Over 10 words (Add per word)	3.62	4.70	
	Easel back on sign (Up to 22" x 28")	4.83	6.23	
	Logo sign	Quoted on Request		
	Banner	Quoted on Request		

### DIGITAL GRAPHICS (6 SQ FT MINIMUM)

- Digital files must be provided to LES specifications.
- Graphics should be sent in vector format as .eps files.  
 Also acceptable: Adobe Illustrator (.ai) & Corel Draw (.cdr) files
- Photographic & Pixel based complex graphics must be MINIMUM 100 dpi at actual output size.  
 Acceptable formats include: .tif, .bmp, & Adobe Photoshop & Corel Photo Paint files
- All text **MUST** be outlined / converted to curves, or fonts included with image files.
- Art work is to be received as file ready.
- Editing & Design time is charged at a rate of \$75.00 per hour (1 hour minimum).
- Digital files must be received at least three (3) weeks before show to receive discount price.

Quantity	Description	Discount Rate	Standard Rate	Total
	Digital Prints per sq.ft. (Mounted on Foamcore w/ Matte Laminat)	\$19.50	\$29.00	

### EXHIBITOR INFORMATION

COMPANY

CONTACT

**BOOTH#**

### INDICATE YOUR SIGN COPY HERE

### ADDITIONAL SERVICES & TERMS

If you would like us to provide more information and pricing on banners, logos, silk screening, special graphics or any other items please contact our Exhibits department for a complimentary consultation.

**Orders required within 72 hours before show opening may be subject to a rush delivery charge.** Please allow a minimum of 24 hours for any on-site sign orders.

#### CHOOSE YOUR LAYOUT

 Vertical

 Horizontal

Levy Exposition Services Inc.  
to design layout

Vertical

Horizontal

#### LETTER COLOR SELECTIONS

Blue  Red  Green  Teal  Black  Purple

Black lettering will be provided unless otherwise specified.

### SPECIAL INSTRUCTIONS

---



---



---

### COST SUMMARY

RATE ADJUSTMENT	(OFFICE USE ONLY)	
100% CANCELLATION FEE	(OFFICE USE ONLY)	
SUBTOTAL		
10.25% SALES TAX		
<b>TOTAL</b>	<b>US DOLLARS</b>	

## PLEASE REFER TO THE PAYMENT & CREDIT CARD CHARGE AUTHORIZATION FORM

**\*\*ORDERS WILL NOT BE PROCESSED WITHOUT PAYMENT\*\***

**STANDARD RATE** will be applied to all orders not received and paid in full by **March 3, 2023**. We reserve the right to adjust orders calculated incorrectly.

**A 100% CANCELLATION FEE** will be applied to all orders received then cancelled.

## PLANT & FLOWER RENTAL ORDER FORM & INVOICE

### LIVE PLANTS

Quantity	Description	Discount Rate	Standard Rate	Total
	Potted flowers	58.00	75.40	
	Boston fern	64.00	83.20	
	Hanging green plant	64.00	83.20	

### LIVE TROPICAL PLANTS

Quantity	Description	Discount Rate	Standard Rate	Total
	3' - 4' tall floor plant	92.00	119.20	
	4' - 5' tall floor plant	109.00	141.70	
	6' tall floor plant	134.00	174.20	

### COLORFUL FRESH CUT FLOWERS

Quantity	Description	Discount Rate	Standard Rate	Total
	Small floral arrangement	205.00	266.50	
	Large floral arrangement	260.00	338.00	

Please indicate color preference here, if any: \_\_\_\_\_  
 \_\_\_\_\_  
 \_\_\_\_\_

The above items are priced on a rental basis only. Price includes container, delivery, installation and removal at the end of show. Any items missing from the booth upon dismantling are the responsibility of the exhibitor and an additional charge will be applied.

### SPECIAL INSTRUCTIONS

\_\_\_\_\_  
 \_\_\_\_\_  
 \_\_\_\_\_

### EXHIBITOR INFORMATION

COMPANY \_\_\_\_\_

CONTACT \_\_\_\_\_

**BOOTH#** \_\_\_\_\_

### COST SUMMARY

RATE ADJUSTMENT	(OFFICE USE ONLY)	
25% CANCELLATION FEE	(OFFICE USE ONLY)	
SUBTOTAL		
10.25% SALES TAX		
<b>TOTAL</b>	<b>US DOLLARS</b>	

**PLEASE REFER TO THE PAYMENT & CREDIT CARD CHARGE AUTHORIZATION FORM**

**\*\*ORDERS WILL NOT BE PROCESSED WITHOUT PAYMENT\*\***

**STANDARD RATE** will be applied to all orders not received and paid in full by **March 3, 2023**. We reserve the right to adjust orders calculated incorrectly.

**A 25% CANCELLATION FEE** will be applied to all orders received then canceled. If full service has been provided then 100% of original fee will be applied.



Fax: 253 437 0032  
 14900 Interurban Avenue South, Suite 271  
 Seattle, WA  
 USA 98168  
 Telephone: 253 437 0031  
 E-mail: operations@levyexpo.com

2023 American Society for Biochemistry and  
 Molecular Biology Annual Meeting (ASBMB)  
 March 25 - 28, 2023  
 Seattle Convention Center  
 Seattle, WA

# EXHIBIT BOOTH CLEANING ORDER FORM & INVOICE

## SERVICES

OUR SERVICES INCLUDE THE FOLLOWING:

EXHIBIT VACUUMING

EMPTYING OF WASTEBASKETS

GENERAL HOUSEKEEPING

## DISCOUNT RATE

TOTAL SQUARE FEET OF BOOTH SPACE	DAYS REQUIRED	RATE	TOTAL
	<input type="checkbox"/> Prior To Show Opening <input type="checkbox"/> After Second Day	<input type="checkbox"/> After First Day <input type="checkbox"/> After Third Day	
_____	X _____	X \$0.78 =	_____
100 Square Feet Minimum Order	Total Number of Days		

## STANDARD RATE & ON-SITE ORDERS

TOTAL SQUARE FEET OF BOOTH SPACE	DAYS REQUIRED	RATE	TOTAL
	<input type="checkbox"/> Prior To Show Opening <input type="checkbox"/> After Second Day	<input type="checkbox"/> After First Day <input type="checkbox"/> After Third Day	
_____	X _____	X \$0.98 =	_____
100 Square Feet Minimum Order	Total Number of Days		

## ADDITIONAL INFORMATION

General vacuuming of the show floor aisles is provided, however, cleaning of your exhibit area is not included in your exhibit space rental.

If you have any questions or need assistance with any items not listed, please contact our exhibits department.

All carpets ordered from us are installed clean for your use. However, you may order cleaning services for debris created during set-up and show hours.

A surcharge may be applied for any damage and or staining of exhibit space.

## SPECIAL INSTRUCTIONS

Please indicate on the lines below any special cleaning requests or instructions you may have.

## EXHIBITOR INFORMATION

COMPANY \_\_\_\_\_

CONTACT \_\_\_\_\_

**BOOTH#** \_\_\_\_\_

## COST SUMMARY

RATE ADJUSTMENT	(OFFICE USE ONLY)	
25% CANCELLATION FEE	(OFFICE USE ONLY)	
SUBTOTAL		
10.25% SALES TAX		
<b>TOTAL</b>	<b>US DOLLARS</b>	

**PLEASE REFER TO THE PAYMENT & CREDIT CARD CHARGE AUTHORIZATION FORM**

**\*\*ORDERS WILL NOT BE PROCESSED WITHOUT PAYMENT\*\***

**STANDARD RATE** will be applied to all orders not received and paid in full by **March 3, 2023**. We reserve the right to adjust orders calculated incorrectly.

**A 25% CANCELLATION FEE** will be applied to all orders received then canceled. If full service has been provided then 100% of original fee will be applied.





**Fax: 253 437 0032**  
 14900 Interurban Avenue South, Suite 271  
 Seattle, WA  
 USA 98168  
 Telephone: 253 437 0031  
 E-mail: operations@levyexpo.com

**2023 American Society for Biochemistry and  
 Molecular Biology Annual Meeting (ASBMB)**  
 March 25 - 28, 2023  
 Seattle Convention Center  
 Seattle, WA

# IN-BOOTH FORKLIFT ORDER FORM & INVOICE

## TERMS & CONDITIONS

The exhibitor, his agent or representative must supply sufficient manpower including competent and authorized supervisors to manage and control the exhibit installation activity.

The exhibitor, upon signing this order form, covenants and agrees to indemnify and hold harmless Levy Exposition Services Inc., from and against all claims, demands, charges, losses or damage arising or alleged to arise directly or indirectly or incidentally by person of any act omission or operations of the exhibitor, his agent or representative, their officers, employees, agents or anyone for whom the exhibitor, his agent or representative are legally responsible. Levy Exposition Services Inc., is to be cross insured on the insurance for the exhibitor's, his agent's or representative's operations conducted at this event. Evidence of the insurance described above shall be forwarded to Levy Exposition Services Inc.

**THIS SERVICE IS NOT PROVIDED BY SHOW MANAGEMENT**

## RATES

DESCRIPTION	STANDARD RATE	
<b>STRAIGHT TIME</b> 8:00 AM - 4:30 PM Monday to Friday (Includes 5000 lb. Forklift and operator)	\$215.00 per Hour	
<b>STRAIGHT TIME</b> 8:00 AM - 4:30 PM Monday to Friday (Foreman)	\$136.75 per Hour	
<b>OVERTIME</b> 4:30 PM - 8:00 AM Monday to Friday, (Includes 5000 lb Forklift and operator) All day Saturday, Sunday, and holidays	\$322.50 per Hour	
<b>OVERTIME</b> 4:30 PM - 8:00 AM Monday to Friday, (Foreman) All day Saturday, Sunday, and holidays	\$205.75 per Hour	

## ESTIMATED INSTALLATION REQUIREMENTS

DESCRIPTION	STANDARD RATE	TOTAL	
<b>STRAIGHT TIME</b> _____ Forklift _____ Hours	\$215.00 per Hour	\$_____ Total	There is a minimum charge of one (1) hour per forklift. Additional time thereafter is charged in one-half (½) hour increments.  Date Required _____ Start Time _____
<b>OVERTIME</b> _____ Forklift _____ Hours	\$322.50 per Hour	\$_____ Total	

## ESTIMATED DISMANTLE REQUIREMENTS

DESCRIPTION	STANDARD RATE	TOTAL	
<b>STRAIGHT TIME</b> _____ Forklift _____ Hours	\$215.00 per Hour	\$_____ Total	There is a minimum charge of one (1) hour per forklift. Additional time thereafter is charged in one-half (½) hour increments.  Date Required _____ Start Time _____
<b>OVERTIME</b> _____ Forklift _____ Hours	\$322.50 per Hour	\$_____ Total	

## EXHIBITOR INFORMATION

COMPANY \_\_\_\_\_

CONTACT \_\_\_\_\_ **BOOTH#** \_\_\_\_\_

## COST SUMMARY

RATE ADJUSTMENT	(OFFICE USE ONLY)	
25% CANCELLATION FEE	(OFFICE USE ONLY)	
SUBTOTAL		
ADDITIONAL 25% LATE ORDER		
<b>TOTAL</b>	<b>US DOLLARS</b>	

**\*PLEASE ADD 25% FOR ORDERS PLACED AFTER  
 MARCH 3, 2023**

**PLEASE REFER TO THE PAYMENT & CREDIT CARD CHARGE AUTHORIZATION FORM**

\*\*ORDERS WILL NOT BE PROCESSED WITHOUT PAYMENT\*\*

**A 25% CANCELLATION FEE** will be applied to all orders received then canceled. If full service has been provided then 100% of original fee will be applied.



**Fax: 253 437 0032**  
 14900 Interurban Avenue South, Suite 271  
 Seattle, WA  
 USA 98168  
 Telephone: 253 437 0031  
 E-mail: operations@levyexpo.com

**2023 American Society for Biochemistry and  
 Molecular Biology Annual Meeting (ASBMB)**  
 March 25 - 28, 2023  
 Seattle Convention Center  
 Seattle, WA

## SIGN & BANNER HANGING ORDER FORM & INVOICE

### TERMS AND CONDITIONS

This order form is for labor and equipment that may be required for the hanging of signs, banners, decorations, etc. This order will be considered as a tentative reservation and **must be confirmed with a signed work order** at the Levy Exposition Services Inc. service desk.

A sign hanging crew consists of two men and a boom lift.

### LABOR RATES

<b>REGULAR TIME</b>	8:00 AM - 4:30 PM Monday to Friday	Boom lift and two man crew - \$790.00 per Hour/ <b>minimum 1 hour</b> Additional Rigger(s) - \$136.75 per Person per Hour / <b>minimum 1 hour</b>
<b>OVER TIME</b>	4:30 PM - 8:00 AM Monday to Friday, All day Saturday, Sunday and Holidays	Boom lift and two man crew - \$980.00 per Hour/ <b>minimum 1 hour</b> Additional Rigger(s) - \$205.75 per Person per Hour/ <b>minimum 1 hour</b>

### ESTIMATED INSTALLATION REQUIREMENTS

REGULAR TIME	Laborers	Date Required	Start Time	Approx. Hours	Boom lift and two man crew - \$790.00 per Hour Additional Rigger(s) - \$136.75 per Person per Hour	\$ _____ Total
OVER TIME	Laborers	Date Required	Start Time	Approx. Hours	Boom lift and two man crew - \$980.00 per Hour Additional Rigger(s) - \$205.75 per Person per Hour	\$ _____ Total

### ESTIMATED DISMANTLE REQUIREMENTS

REGULAR TIME	Laborers	Date Required	Start Time	Approx. Hours	Boom lift and two man crew - \$790.00 per Hour Additional Rigger(s) - \$136.75 per Person per Hour	\$ _____ Total
OVER TIME	Laborers	Date Required	Start Time	Approx. Hours	Boom lift and two man crew - \$980.00 per Hour Additional Rigger(s) - \$205.75 per Person per Hour	\$ _____ Total

All Rates are based on current wage scales and are subject to change in accordance with existing wage scales at the time of the exposition.

**NOTE:** Any miscellaneous rigging supplies such as cable, shackles etc. required to install your sign will be calculated and added to your invoice upon completion of the installation

\*PLEASE ADD 25% TO ORDERS PLACED AFTER **MARCH 3, 2023**.

### SPECIAL INSTRUCTIONS

---



---



---



---

### EXHIBITOR INFORMATION

COMPANY \_\_\_\_\_

CONTACT \_\_\_\_\_

**BOOTH#**

### COST SUMMARY

RATE ADJUSTMENT	(OFFICE USE ONLY)	
25% CANCELLATION FEE	(OFFICE USE ONLY)	
SUBTOTAL		
ADDITIONAL 25% LATE ORDER		
<b>TOTAL</b>	<b>US DOLLARS</b>	

**PLEASE REFER TO THE PAYMENT & CREDIT CARD CHARGE AUTHORIZATION FORM**

\*\*ORDERS WILL NOT BE PROCESSED WITHOUT PAYMENT\*\*



Fax: 253 437 0032  
 14900 Interurban Avenue South, Suite 271  
 Seattle, WA  
 USA 98168  
 Telephone: 253 437 0031  
 E-mail: operations@levyexpo.com

2023 American Society for Biochemistry and  
 Molecular Biology Annual Meeting (ASBMB)  
 March 25 - 28, 2023  
 Seattle Convention Center  
 Seattle, WA

# LABOR ORDER FORM & INVOICE

## SUPERVISION SERVICES (Please indicate desired service)

### LEVY EXPOSITION SERVICES INC. SUPERVISED

MOVE IN                       MOVE OUT

LEVY EXPOSITION SERVICES INC. WILL SUPERVISE labor to unpack and install display before exhibitor arrival at show site and/or dismantle and pack display after show closing.

A 50% **Surcharge** will be added to the labor rates below for this professional supervision.

### EXHIBITOR SUPERVISED

MOVE IN                       MOVE OUT

EXHIBITOR WILL SUPERVISE the laborers provided by Levy Exposition Services Inc. for the installation and/or dismantle of the exhibit.

Supervisor's name \_\_\_\_\_

Starting time can be guaranteed only when labor is requested for the start of the working day at 8 AM. For all other starting times, check in at the **Exhibitor Service Desk** one-half (1/2) hour before time requested.

## LABOR RATES

<b>REGULAR TIME</b>	8:00 AM - 4:30 PM Monday to Friday	\$136.75 per Hour
<b>OVER TIME</b>	Before 8:00 am and after 4:30 pm Monday to Friday, All day Saturday, Sunday, and holidays.	\$205.75 per Hour

## ESTIMATED INSTALLATION REQUIREMENTS

<b>REGULAR TIME</b>	____ Laborers	____ Hours	\$136.75 per Hour	\$ _____ Total	<b>A minimum charge for labor is one (1) hour per laborer. Labor thereafter is charged in one-half (1/2) hour increments.</b> Date Required _____ Start Time _____
<b>OVER TIME</b>	____ Laborers	____ Hours	\$205.75 per Hour	\$ _____ Total	

## ESTIMATED DISMANTLE REQUIREMENTS

<b>REGULAR TIME</b>	____ Laborers	____ Hours	\$136.75 per Hour	\$ _____ Total	<b>A minimum charge for labor is one (1) hour per laborer. Labor thereafter is charged in one-half (1/2) hour increments.</b> Date Required _____ Start Time _____
<b>OVER TIME</b>	____ Laborers	____ Hours	\$205.75 per Hour	\$ _____ Total	

## INBOUND FREIGHT INFORMATION **\*\*BE SURE TO COMPLETE THE OUTBOUND FORM AS WELL\*\***

Carrier	Date Shipped	Pro Number
Number of Pieces	Weight	Arrival Date (Target)
<input type="checkbox"/> Loose Display <input type="checkbox"/> Crated Display		
Quantity of Ladders Required (Optional) _____		

## EXHIBITOR INFORMATION

COMPANY _____
CONTACT _____
<b>BOOTH#</b> _____

**\*PLEASE ADD 25% FOR ORDERS PLACED AFTER MARCH 3, 2023**

## COST SUMMARY

RATE ADJUSTMENT	(OFFICE USE ONLY)	
CANCELLATION FEE	(OFFICE USE ONLY)	
SUBTOTAL		
SUPERVISION 50%		
ADDITIONAL 25% LATE ORDER		
<b>TOTAL US DOLLARS</b>		

**PLEASE REFER TO THE PAYMENT & CREDIT CARD CHARGE AUTHORIZATION FORM**  
**\*\*ORDERS WILL NOT BE PROCESSED WITHOUT PAYMENT\*\***

**TERMS & CONDITIONS** Gratuities in any form, including cash, gifts or labor hours for work not actually performed are prohibited. We reserve the right to adjust orders calculated incorrectly.

**CANCELLATION FEE** A one (1) hour "per person, per hour" charge will be applied for all canceled labor orders.

## OUTBOUND SHIPPING - BOOTH I&D LABOR

<b>Exhibitor Name:</b>	<b>Tel. #:</b>	<b>Booth #</b>
<b>Billing Address:</b>	<b>Fax #:</b>	
<b>City / State / Zip:</b>	<b>Auth. by:</b>	

### 1 Outbound Shipping Instructions

*Please complete this section if Levy will be supervising booth labor.*

*Exhibitor Outbound Shipping Instructions: At close of show, exhibitor freight will be shipped to the following address:  
 If your freight is being forwarded to another show, be sure to include the name of show and your booth number.*

**Company / Show:** \_\_\_\_\_ **Booth #:** \_\_\_\_\_

**Address:** \_\_\_\_\_

**City / State / Zip:** \_\_\_\_\_

**Attention:** \_\_\_\_\_

Select Carrier

Ship via carrier of exhibitor's choice

**Name of Carrier:** \_\_\_\_\_

Ship via official show freight carrier

Select shipping method  Ground  Air **Select Service Provider:** \_\_\_\_\_

Please note:

- If an exhibitor is using a carrier of his/her own choice (or not using the official show freight carrier,) the exhibitor is responsible for arranging for carrier to pick up at close of show.
- Levy cannot guarantee pick up time for exhibitor appointed carriers. All shipments are moved out of the exhibit hall at Levy's discretion.

### Please review the Quick Facts for the Carrier Check-in time

### 2 Billing Information

*Please indicate billing information for carrier charges if different than above.*

*Bill Shipping Charges to (if different from above):*

**Shipper (signature):** \_\_\_\_\_ **Shipper (print name):** \_\_\_\_\_

**Freight Charges Billed To (Company/Show):** \_\_\_\_\_

**Address:** \_\_\_\_\_

**City / State / Zip:** \_\_\_\_\_

**Telephone:** \_\_\_\_\_ **Attention:** \_\_\_\_\_

# PAYMENT & LABOR

The terms and conditions set forth below become part of the contractual agreement between Levy Exposition Services Inc. and you, the EXHIBITOR. Acceptance of said terms and conditions will be construed when any of the following conditions are met:

- ~ **WHEN THE METHOD OF PAYMENT FORM IS SIGNED; OR**
- ~ **WHEN AN ORDER FOR LABOR, SERVICES, AND/OR RENTAL EQUIPMENT IS PLACED BY AN EXHIBITOR WITH LEVY EXPOSITION SERVICES INC.; OR**
- ~ **WHEN WORK IS PERFORMED ON BEHALF OF EXHIBITOR BY LABOR SECURED THROUGH LEVY EXPOSITION SERVICES INC.**

## DEFINITIONS

"Levy Exposition Services Inc." ("LES"), and any sub-contractors affiliated within the show. The term EXHIBITOR shall be construed within the meaning of this contract as the EXHIBITOR and/or its employees, agents, representatives, and/or any Exhibitor Appointed Contractor (E.A.C.).

## PAYMENT TERMS

Full payment, including any applicable tax, is due in advance or at show site. All payments must be in U.S. Funds and all checks must be drawn on a U.S. Bank. Orders received without advance payment or after the deadline date will incur additional [After Deadline] charges as indicated on each order form. All materials and equipment are on a rental basis for the duration of the show or event and remain the property of LES except where specifically identified as a sale. All LES rentals include delivery, installation and removal from EXHIBITOR's booth, unless stated otherwise. In case of cancellation, a one-hour "per person, per hour" charge will be applied to all labor, forklift and sign hanging orders that are not canceled in writing at least seven (7) days prior to the scheduled start time. If services have already been provided at the time of cancellation, 100% of original fee will be applied. It is EXHIBITOR'S responsibility to advise LES Exhibitor Services personnel of any problem with any order, and to check invoices for accuracy prior to the close of the exhibit. If EXHIBITOR is exempt from payment of sales tax, LES requires an exemption certificate for the State in which the services are to be used. Resale certificates are not valid unless EXHIBITOR is rebilling these charges to its customers. For International EXHIBITORS, LES requires 100% prepayment of advance orders, and any orders or services placed at show site must be paid at the show. For all others, should there be any pre-approved unpaid balance after the close of the show, terms will be net, due and payable in the UNITED STATES OF AMERICA, upon receipt of invoice. Effective 30 days after invoice date, any unpaid balance will bear a FINANCE CHARGE at the lesser of the maximum rate allowed by applicable law, or 1.5% per month, which is an ANNUAL PERCENTAGE RATE of 18%, and future orders will be on a pre-paid basis only. If any finance charge here under exceeds the maximum rate allowed by applicable law, the finance charge shall automatically be reduced to the maximum rate allowed, and any excess finance charge received by LES shall either be applied to reduce the principal unpaid balance or refunded to the payer. These payment terms and conditions shall be governed by and construed in accordance with the LAWS OF THE STATE OF WASHINGTON. In the event of any dispute between EXHIBITOR and LES relative to any loss, damage, or claim, such EXHIBITOR shall not be entitled to and shall not withhold payment, or any partial payment, due to LES relative to any services, as an offset against the amount of any alleged loss or damage. Any claim against LES shall be considered a separate transaction, and shall be resolved on its own merits. LES reserves the right to charge EXHIBITOR for the difference between the EXHIBITOR's estimate of charges and the actual charges incurred by the EXHIBITOR, or for any charges that LES may be obligated to pay on behalf of the EXHIBITOR, including without limitation, any shipping charges.

## LABOR PROVIDED UNDER THE SUPERVISION OF LES

### RESPONSIBILITIES

LES shall be responsible for the performance of labor provided under this option. LES cannot assume responsibility for any acts of, or loss to, persons, parties and/or other contracting firms not under LES's direct supervision and control. In no event shall LES be liable for loss or damage caused by delay in labor beginning work when EXHIBITOR requests labor to begin later than the start of the working day. LES shall not be responsible for loss, delay or damage due to strike, lockouts, and/or work stoppages, or other causes beyond LES's reasonable control.

### INDEMNIFICATION

LES agrees to indemnify, hold harmless, and defend EXHIBITOR from and against any and all demands, claims, causes of action, fines, penalties, damages, liabilities, judgments, and expenses (including but not limited to reasonable attorneys' fees and investigation costs) for bodily injury, including any injury to LES employees, or property damage arising out of work performed by labor provided by and supervised by LES, except when EXHIBITOR exercises direction and/or control over the work being performed.

## LABOR PROVIDED UNDER THE SUPERVISION OF EXHIBITOR

### RESPONSIBILITIES

EXHIBITOR shall be responsible for the performance of labor provided under this section. It is responsibility of EXHIBITOR to supervise labor secured through LES in a reasonable manner as to prevent bodily injury and/or property damage and also to direct them to work in a manner that is in compliance with LES Safe Work Rules and/or Federal, State, County and Local ordinances, rules and/or regulations, including but not limited to Show or Facility Management Rules and/or Regulations. It is the responsibility of EXHIBITOR to check in with the Service Desk to pick up labor, and to return to the Service Desk to release labor when the work is completed.

### INDEMNIFICATION

EXHIBITOR agrees to indemnify, hold harmless, and defend LES from and against any and all demands, claims, causes of action, fines, penalties, damages, liabilities, judgements, and expenses (including but not limited to reasonable attorneys' fees and investigation costs) for bodily injury, including any injury to LES employees, and/or property damage arising out of work performed by labor provided by LES but supervised by EXHIBITOR. Further, EXHIBITOR's indemnification of LES includes any and all violations of Federal, State, County or Local ordinances, "Show Regulations and/or Rules" as published and/or set forth by Facility or Show Management, and/or directing labor provided by LES to work in a manner that violates any of the above rules, regulations, and/or ordinances.

### IMPORTANT

**PLEASE REFER TO LES's MATERIAL HANDLING TERMS AND CONDITIONS AS THEY RELATE TO MATERIAL HANDLING SERVICES. CONTRACTUAL TERMS DEPEND ON THE NATURE OF SERVICES SECURED BY EXHIBITOR THROUGH LES. TERMS & CONDITIONS MAY VARY FOR EACH TYPE OF SERVICE ORDERED THROUGH LES.**

TERMS & CONDITIONS



# SOLO RATE

ONE RATE. ONE FEE.

**LEVY**  
EXPOSITION SERVICES INC.



THE SIMPLIFIED PRICING OF PAYING PER POUND INCLUDES:

- Receiving and unloading your materials at the advance warehouse.
- Secure storage of materials for up to 30 days before the show.
- Transfer to show-site, unload, and deliver materials to your booth.
- Removal and storage of empty containers during the show.
- Returning empties from storage at the close of the show.
- Outbound loading of your materials onto your carrier of choice or Levy's official carrier.



# MATERIAL HANDLING FAQs

The following is a list of frequently asked questions pertaining to material handling and freight services. We strongly recommend that you read this document in its entirety to better familiarize yourself with the processes relating to material handling and freight services.

As the official service contractor, LEVY is the exclusive provider of freight services. Material handling includes unloading your exhibit material, storing up to 30 days in advance at the warehouse address, delivering to the booth, the handling of empty containers to and from storage, and removing of material from the booth for reloading onto outbound carriers. It should not be confused with the cost to transport your exhibit material to and from the convention or event. You have two options for shipping your advance freight — either to the warehouse or directly to show site.

## HOW DO I SHIP TO THE ADVANCE WAREHOUSE?

- We will accept freight beginning 30 days prior to show move-in.
- To check on your freight arrival, call Exhibitor Services at the number listed on the Quick Facts.
- To ensure timely arrival of your materials at show site, freight should arrive by the deadline date listed on the Quick Facts and Shipping Instructions pages. Your freight will still be received after the deadline date, but additional charges will be incurred.
- The warehouse will receive shipments Monday through Friday, except holidays. Refer to the Shipping Instructions page for warehouse receiving hours.
- The warehouse will accept crates, cartons, skids, trunks/cases and carpets. Loose or pad-wrapped materials must be sent directly to show site.
- All shipments must have a bill of lading or delivery slip indicating the number of pieces, type of merchandise and weight.
- Certified weight tickets must accompany all shipments.
- Warehouse freight will be delivered to the booth prior to exhibitor setup.
- Please call the number located on the Quick Facts if you want to ship oversized material that requires special equipment to the warehouse.

## HOW DO I SHIP TO SHOW SITE?

- Freight will be accepted only during exhibitor move-in. Please refer to the Quick Facts for the specific exhibitor move-in dates and times.
- All shipments must have a bill of lading or delivery slip indicating the number of pieces, type of merchandise and weight.
- Certified weight tickets must accompany all shipments.

## WHAT ABOUT PREPAID OR COLLECT SHIPPING CHARGES?

- Collect shipments will be returned to the delivery carrier.
- To ensure that your freight does not arrive “collect,” mark your bill of lading “prepaid.”
- “Prepaid” designates that the transportation charges will be paid by the exhibitor or a third party.

## HOW SHOULD I LABEL MY FREIGHT?

- The label should contain the exhibiting company name, the booth number and the name of the event.
- The specific shipping address for either the warehouse or show site can be found on the Quick Facts and Shipping Instructions pages.

## HOW DO I ESTIMATE MY MATERIAL HANDLING CHARGES?

- Charges will be based on the weight of your shipment. Each shipment received is considered separately. The shipment weight will be multiplied by the applicable per pound rate with no round-ups. All shipments are subject to reweigh.
- On the Order Form, select whether the freight will arrive at the warehouse or be sent directly to show site.

**Crated:** material that is skidded or is in any type of shipping container that can be unloaded at the dock with no additional handling required.

- Add the late delivery charge listed on the Order Form if the shipment is accepted at the warehouse or at show site after the deadline date listed on the Quick Facts and Shipping Instructions pages.
- The above services, whether used completely or in part, are offered as a package and the charges will be based on the total inbound weight of the shipment.
- Shipments received without receipts or freight bills, such as UPS and Federal Express, will be delivered to the booth without guarantee of piece count or condition.

## WHAT HAPPENS TO MY EMPTY CONTAINERS DURING THE SHOW?

- Pick up “Empty Labels” at the Service Center. Place a label on each container. Labeled containers will be picked up periodically and stored in non-accessible storage during the show.
- At the close of the show, the empty containers will be returned to the booth in random order. Depending on the size of the show, this process may take several hours.
- *Please note that LEVY will assume no liability for interrupted travel plans due to the length of time required for the empty container return. It is the responsibility of the exhibitor to schedule travel plans accordingly.*

## HOW DO I PROTECT MY MATERIALS AFTER THEY ARE DELIVERED TO THE SHOW OR BEFORE THEY ARE PICKED UP AFTER THE SHOW?

- Consistent with trade show industry practices, there may be a lapse of time between the delivery of your shipment(s) to your booth and your arrival. The same is true for the outbound phase of the show — the time between your departure and the actual pick-up of your materials. During these times, your materials will be left unattended. We recommend that you arrange for a representative to stay with your materials or that you hire security services to safeguard your materials.

## HOW DO I SHIP MY MATERIALS AFTER THE CLOSE OF THE SHOW?

- Each shipment must have a completed Material Handling Agreement in order to ship materials from the show. All pieces must be labeled individually.
- To save time, complete and submit the Outbound Shipping Form in advance, or you may contact the Service Center at show site for your shipping documents. The Material Handling Agreement and labels will be processed and available prior to show closing.
- After materials are packed, labeled, and ready to be shipped, the completed Material Handling Agreement must be turned in at the Service Center.
- Call your designated carrier with pick-up information. Please refer to the Quick Facts and Shipping Instructions pages for specific dates and times. In the event your selected carrier fails to show on final move-out day, your shipment will either be rerouted to LEVY’s carrier choice or delivered back to the warehouse at exhibitor’s expense.
- For your convenience, show-recommended carriers will be on site to handle outbound transportation.

## WHERE DO I GET A FORKLIFT?

- Forklift orders to install or dismantle your booth after materials are delivered may be ordered in advance or at show site. We recommend that you order in advance to avoid additional charges at show site. Refer to the Order Form for available equipment.
- Advance and show-site orders for equipment and labor will be dispatched once a company representative signs the labor order at the Service Center.
- Start time is guaranteed only when equipment is requested for the start of the working day.

## DO I NEED INSURANCE?

- Be sure your materials are insured from the time they leave your firm until they are returned after the show. It is suggested that exhibitors arrange all-risk coverage. This can be done by riders to your existing policies.
- All materials handled by LEVY are subject to the enclosed Terms and Conditions.

## OTHER AVAILABLE SERVICES (may not be available in all locations)

- Cranes
- Scissor lifts, condors
- Access storage at show site
- Exhibit transportation services (see enclosed Liberty Convention Freight form)
- Security storage at show site
- Short-term and long-term warehouse storage
- Local pick-up and delivery



**Fax: 253 437 0032**  
 14900 Interurban Avenue South, Suite 271  
 Seattle, WA  
 USA 98168  
 Telephone: 253 437 0031  
 E-mail: operations@levyexpo.com

**2023 American Society for Biochemistry and  
 Molecular Biology Annual Meeting (ASBMB)**  
 March 25 - 28, 2023  
 Seattle Convention Center  
 Seattle, WA

# SOLO RATE MATERIAL HANDLING ORDER FORM & INVOICE

## SOLO RATE MATERIAL HANDLING SERVICES

**DUE TO LIMITED MATERIAL HANDLING SERVICES AT THE SEATTLE CONVENTION CENTER, WE HIGHLY RECOMMEND THAT ALL MATERIALS BE SHIPPED TO OUR ADVANCE WAREHOUSE IN ORDER TO AVOID POTENTIAL DELAYS IN UNLOADING AT SHOW SITE.**

**Material Handling Service:**

Levy Exposition Services Inc. is the exclusive provider of Solo Rate Material Handling Services for ASBMB. Solo Rate Material Handling Services include:

- receiving and unloading your exhibit materials at the advance warehouse
- storage of exhibit materials for up to 30 days prior to the show
- transportation to show site, unloading and delivery of exhibit materials to your booth space,
- removal and storage of your empty containers during the event
- return of your empty containers at the close of the event
- outbound loading of your materials onto your carrier vehicle of choice at show site

You have the choice to ship to the advance warehouse prior to the show or to ship directly to the show site where your materials must arrive within the exhibitor move-in dates and times.

## SOLO RATE MATERIAL HANDLING DESCRIPTIONS

**Normal Warehouse Hours for Receiving Freight:** 8:00 A.M. to 3:00 P.M. Monday through Friday, Holidays excluded.

**Advance Receiving:** Shipment(s) received at the Advance Warehouse *between February 17, 2023 and March 17, 2023.*

**Early/Late to Warehouse & Off Target:** Shipment(s) received at the Advance Warehouse *prior to February 17, 2023 or after March 17, 2023.* Shipments received at show site prior to **8:00 am on Friday, March 24, 2023.**

**Show Site Receiving:** Shipment(s) shipped to and received at the **Seattle Convention Center.** Shipments cannot be received at the **Seattle Convention Center** prior to **8:00 am on Friday, March 24, 2023.**

**Dedicated Delivery from Advance Warehouse:** Any freight received at the Advance Warehouse after **March 21, 2023** could incur a \$650.00 delivery fee if a dedicated truck is required to deliver freight to show site.

Advance and Direct Shipment Rates	Price Per lb.
Advance Warehouse & Show Site Receiving Rate .....	\$2.15
Early/Late to Warehouse & Off Target Rate.....	\$2.55
Dedicated Delivery from Advance Warehouse (in addition to material handling rates).....	\$650.00 (flat fee)

**PLEASE NOTE:**

Acceptance of Terms & Conditions will be construed when the Material Handling Service Agreement is signed; or when exhibitor's materials are delivered to Levy Exposition Services Inc. warehouse or to a SHOW / EXPOSITION SITE for which Levy Exposition Services Inc. is the official show contractor.

Description	Weight in LBS	Price Per lb.	Estimated Total Charges
Advance Receiving - 1 crate, 2 boxes	298	\$2.15	\$640.70

### EXHIBITOR INFORMATION

COMPANY \_\_\_\_\_

CONTACT \_\_\_\_\_ **BOOTH#** \_\_\_\_\_

RATE ADJUSTMENT	(OFFICE USE ONLY)	
SUBTOTAL		
<b>TOTAL</b>	<b>US DOLLARS</b>	

**PLEASE REFER TO THE PAYMENT & CREDIT CARD CHARGE AUTHORIZATION FORM**  
 \*\*ORDERS WILL NOT BE PROCESSED WITHOUT PAYMENT\*\*



## SHIPPING INSTRUCTIONS

SHIPMENTS CAN BE SENT DIRECTLY TO THE SHOW-SITE ON MOVE-IN DAY, OR TO THE ADVANCE WAREHOUSE UP TO THIRTY DAYS PRIOR TO MOVE-IN.

All freight shipped to the advance receiving warehouse must be properly crated, boxed, or stretch wrapped on pallets.

### ADVANCE RECEIVING

For advance receiving, mail or fax the Material Handling Order Form & Invoice with pre-payment to LEVY EXPOSITION SERVICES INC. Shipments sent collect **WILL NOT** be accepted.

Advance receiving includes the following:

- receiving your material at the warehouse up to thirty days in advance of the move-in day
- delivering the shipment to your booth at the facility
- removing empty crates from your booth to a designated storage area
- returning your empty crates to your booth at the close of the show
- loading your crates onto your designated carrier at the close of the show

The material handling services provided by LEVY EXPOSITION SERVICES INC. end with the close of the show. It is the responsibility of the exhibitor to make appropriate arrangements with a carrier for shipping following the close of the show. Please make special note of the allotted move-out times and days, and confirm with your carrier that they are able to meet these allotted times.

Please remove all old shipping labels and ensure that all freight destined for the advance warehouse is labeled with the following information:

**ASBMB**  
**COMPANY NAME & BOOTH #**  
**Levy Exposition Services Inc.**  
**c/o Liberty CFS NV, Inc.**  
**12855 48th Ave S**  
**Tukwila, WA 98168**

Shipments may be sent to the advance warehouse up to thirty days prior to the move-in day for the show. All shipments however, must be received at the warehouse a minimum of one week (seven days) in advance of the show move-in date. Shipments received less than seven days prior to the move-in day are subject to extra charges and delivery time **will not** be guaranteed. All shipments must be received at the advance warehouse between the hours of 08:00 and 15:00, Monday to Friday, no earlier than **February 17, 2023** and no later than **March 17, 2023**. **Shipments that arrive prior to February 17, 2023 or after March 17, 2023 will be subject to the rate of \$2.55 per pound.**

**ANY SHIPMENT(S) RECEIVED AT THE ADVANCE WAREHOUSE AFTER MARCH 21, 2023 COULD INCUR A CHARGE OF \$650.00 IN ADDITION TO LATE TO WAREHOUSE FEES.**

Shipments must include an official weight ticket or bill of lading.

## **SHIPPING INSTRUCTIONS (CONT'D.)**

### **SHOW-SITE RECEIVING**

For show-site receiving, mail or fax the Material Handling Order Form & Invoice with pre-payment to LEVY EXPOSITION SERVICES INC. Shipments sent collect **WILL NOT** be accepted.

Show-site receiving includes the following:

- receiving and signing for your shipment on your behalf
- delivering the shipment to your booth at the facility
- removing empty crates from your booth to a designated storage area
- returning your empty crates to your booth at the close of the show
- loading your crates onto your designated carrier at the close of the show

The material handling services provided by LEVY EXPOSITION SERVICES INC. end with the close of the show. It is the responsibility of the exhibitor to make appropriate arrangements with a carrier for shipping following the close of the show. Please make special note of the allotted move-out times and days, and confirm with your carrier that they are able to meet these allotted times.

Please remove all old shipping labels and ensure that all freight destined for show-site receiving is labeled with the following information:

**ASBMB**  
**COMPANY NAME & BOOTH #**  
**Seattle Convention Center**  
**c/o Levy Exposition Services Inc.**  
**705 Pike Street**  
**Seattle, WA 98101**

**PLEASE NOTE THAT SHIPMENTS CANNOT BE RECEIVED AT THE SEATTLE CONVENTION CENTER PRIOR TO 8:00 AM ON FRIDAY, MARCH 24, 2023.**

**ALL SHIPMENTS MUST INCLUDE A CERTIFIED WEIGHT TICKET OR BILL OF LADING. IN THE EVENT THAT YOUR SHIPMENT(S) DOES NOT INCLUDE A CERTIFIED WEIGHT TICKET, IT WILL BE WEIGHED ON-SITE AND A SURCHARGE OF (\$0.40) PER POUND WILL BE APPLIED.**

### **LIMITS OF LIABILITY**

See Material Handling Terms & Conditions Sheet enclosed.

# MATERIAL HANDLING

Acceptance of said terms and conditions will be constructed when any of the following conditions are met:

- ~ **THE MATERIAL HANDLING ORDER FORM AND INVOICE IS SIGNED; OR**
- ~ **WHEN EXHIBITOR'S MATERIALS ARE DELIVERED TO LES'S WAREHOUSE OR TO A SHOW/ EXPOSITION SITE FOR WHICH LEVY EXPOSITION SERVICES INC. IS THE OFFICIAL SHOW CONTRACTOR; OR**
- ~ **WHEN AN ORDER FOR LABOR AND/ OR RENTAL EQUIPMENT IS PLACED BY AN EXHIBITOR WITH LEVY EXPOSITION SERVICES INC.**

1. **DEFINITIONS.** "Levy Exposition Services Inc" ("LES"), and any sub-contractors affiliated within the show.
2. **PACKAGING AND CRATES.** LES shall not be responsible for damage to loose, uncrated materials, pad-wrapped or shrink-wrapped materials, glass breakage, concealed damage, carpets in bags or poly, or materials improperly packed. In addition, LES shall not be responsible for crates and packaging which are unsuitable for handling, in poor condition, or have prior damage. Crated and packaging should be of a design to adequately protect contents for handling by forklift and similar means.
3. **EMPTY CONTAINERS.** Empty container labels will be available at the show site service desk. Affixing labels to the containers is the sole responsibility of EXHIBITOR or his representative. All previous labels must be removed or obliterated. LES assumes no responsibility for: Error in the above procedures; Removal of containers with old empty labels & without LES labels; or Improper information on empty labels. LES WILL NOT BE LIABLE FOR LOSS OR DAMAGE TO CRATES AND CONTAINERS OR THEIR CONTENTS WHEN SAID ITEMS ARE IN EMPTY CONTAINER STORAGE.
4. **INBOUND SHIPMENT(S).** Consistent with trade show industry practices, there may be a lapse of time between the delivery of shipment(s) to the booth and the arrival of EXHIBITOR or his representative, and during such time the materials will be left unattended. LES WILL NOT BE RESPONSIBLE OR LIABLE FOR ANY LOSS, DAMAGE, THEFT, OR DISAPPEARANCE OF EXHIBITOR'S MATERIALS AFTER SAME HAVE BEEN DELIVERED TO EXHIBITOR'S BOOTH AT SHOW SITE. LES highly recommends the securing of security services for Facility or Show Management.
5. **OUTBOUND SHIPMENT(S).** Consistent with trade show industry practices, there may be a lapse of time between the completions of packing and the actual pickup of materials from the booths for loading onto a carrier and during such time the materials will be left unattended. LES WILL NOT BE RESPONSIBLE OR LIABLE FOR ANY LOSS, DAMAGE, THEFT, OR DISAPPEARANCE OF EXHIBITOR'S MATERIALS BEFORE SAME HAVE BEEN PICKED UP FOR RELOADING AT THE CONCLUSION OF THE EVENT. LES highly recommends the securing of security services from Facility or Show Management. All Material Handling Agreements submitted to LES by EXHIBITOR will be checked at the time of pickup from booth and corrections will be made where discrepancies exist between the quantities of times listed by EXHIBITOR and the actual count of such items in the booth at the time of pickup.
6. **LES'S RESPONSIBILITIES.** LES shall be responsible only for those services which it directly provides. LES assumes no responsibility for any persons, parties, or other contracting firms not under LES's direct supervision and control. LES shall not be responsible for loss, delay, or damage due to strike, lockouts, work stoppages, natural elements, vandalism, acts of God, civil disturbances, power failure, explosion, acts of terrorism or war, other causes beyond LES's reasonable control, nor for ordinary wear & tear in the handling of materials.
7. **INSURANCE.** It is understood that LES is not an insurer. Insurance on exhibit materials, if any, shall be obtained by EXHIBITOR in amounts and for perils determined by EXHIBITOR. EXHIBITOR agrees to provide LES with a release of subrogation to the extent of any insurance settlement received.
8. **CLAIM(S) FOR LOSS.** Claims for loss or damage must be reported at show-site.
  - A. **PAYMENT FOR SERVICES MAY NOT BE WITHHELD.** In the event of any dispute between the EXHIBITOR shall not be entitled to and shall not withhold payment, or any partial payment due to LES for its services, as an offset against the amount of any alleged loss or damage.
  - B. **MAXIMUM RECOVERY.** If found damaged LES's sole and exclusive MAXIMUM liability for loss or damage to EXHIBITOR's materials and EXHIBITOR's sole and exclusive remedy is limited to \$.50 per pound article with a maximum liability of \$100.00 per item, or \$1,500.00 per shipment.
9. **JURISDICTION.** THIS CONTRACT SHALL BE CONSTRUED UNDER THE LAWS OF THE STATE OF WASHINGTON WITHOUT GIVING EFFECT TO ITS CONFLICT OF LAWS RULES. EXCLUSIVE VENUE FOR ALL DISPUTES ARISING OUT OF OUR RELATING TO THIS CONTRACT SHALL RESIDE IN A COURT OF COMPETENT JURISDICTION IN SEATTLE, WASHINGTON.
10. **INDEMNIFICATION.** EXHIBITOR agrees to indemnify, forever hold harmless and defend LES, its employees, directors, officers, and agents from and against any and all demands, claims, causes of action, fines, penalties, damages (including consequential), liability, judgments, and expenses (including but not limited to reasonable attorney's fees and investigation costs) on account of personal injury, death, or damage to or loss of property or profits arising out of, or contributed to, by any of the following:
  - EXHIBITOR's negligent supervision of any labor secured through LES, or the negligent supervision of such labor by any of EXHIBITOR's employees, agents, representative, customers, invitees and/or Exhibitor Appointed Contractor (EAC).
  - EXHIBITOR's negligence, willful misconduct, or deliberate act of EXHIBITOR's employees, agents, representatives, customers, invitees and/or any Exhibitor Appointed Contractor (EAC) at the show or exposition to which this contract relates.
  - EXHIBITOR's violation of U.S.A. or Local ordinances or the violation of Show Regulations and/or Rules as published and set forth by Facility and/or Show Management.
  - EXHIBITOR's inclusion of illegal substances, hazardous materials or waste in any shipment placed with LES and for the violation of the representations and warranties made regarding hazardous materials made on the front of this Agreement.
11. **MISCELLANEOUS.** EXHIBITOR, as a material part of the consideration LES for material handling and transportation services, waives and releases all claims against LES, its employees, agents, officers, and directors, with respect to all matters for which LES has disclaimed liability pursuant to the provisions of this contract. The EXHIBITOR acknowledges that he or she has read this agreement, understands it and agrees to be bound by its terms, and further agrees that it is the complete and exclusive agreement between the parties. The invalidity or enforceability of any provision hereof shall not affect, modify, or impair the validity and enforceability of all provisions herein.



# ADVANCE WAREHOUSE

TO: \_\_\_\_\_  
(EXHIBITOR NAME)

BOOTH # \_\_\_\_\_

Levy Exposition Services Inc.  
c/o LIBERTY CFS NV, INC.  
12855 48th Ave S  
Tukwila, WA 98168

EVENT NAME: ASBMB

NO. \_\_\_\_\_ # of \_\_\_\_\_ PCS.



# ADVANCE WAREHOUSE

TO: \_\_\_\_\_  
(EXHIBITOR NAME)

BOOTH # \_\_\_\_\_

Levy Exposition Services Inc.  
c/o LIBERTY CFS NV, INC.  
12855 48th Ave S  
Tukwila, WA 98168

EVENT NAME: ASBMB

NO. \_\_\_\_\_ # of \_\_\_\_\_ PCS.

The above labels are provided for your convenience.  
Place one on each piece shipped to the ADVANCE WAREHOUSE.  
**If more labels are needed, copies are acceptable.**



# SHOW SITE

TO: \_\_\_\_\_  
(EXHIBITOR NAME)

BOOTH # \_\_\_\_\_

Seattle Convention Center  
c/o Levy Exposition Services Inc.  
705 Pike Street  
Seattle, WA 98101

EVENT NAME:

ASBMB

NO. \_\_\_\_\_ # of \_\_\_\_\_ PCS.



# SHOW SITE

TO: \_\_\_\_\_  
(EXHIBITOR NAME)

BOOTH # \_\_\_\_\_

Seattle Convention Center  
c/o Levy Exposition Services Inc.  
705 Pike Street  
Seattle, WA 98101

EVENT NAME:

ASBMB

NO. \_\_\_\_\_ # of \_\_\_\_\_ PCS.

The above labels are provided for your convenience.  
Place one on each piece shipped to the SHOW SITE.  
*If more labels are needed, copies are acceptable.*



"Delivering Freedom®"



# MOVE YOUR EXHIBIT WITH PEACE OF MIND

**THE FREIGHT & CUSTOMS PARTNER YOU CAN RELY ON  
FULLY DEDICATED TO YOUR CONVENTION AND TRADE SHOW SUCCESS**

Putting service first and leveraging our 42 years of freight & customs experience



## Transportation Services

- Ground Freight (LTL)
- Full Load
- International Freight Forwarding
- Customs Brokerage Services
- Exclusive Use Full Trailer



## Customized Solutions

- Door to door service
- Catering to your specific needs
- Single point of contact
- 24/7 customer attention
- Committed to excellence

**Dedicated to delivering safely and on time every time.**

**100% satisfaction guaranteed or your money back. That's the Liberty CFS promise.**



**Call Toll Free 1-866-938-1092 or 1.905.338.3993 Fax: 1.905.338.1092  
email: [exhibitorservices@libertycfs.us](mailto:exhibitorservices@libertycfs.us) - [www.libertycfs.us](http://www.libertycfs.us)**

**LAS VEGAS | TORONTO**





# LibertyCFS NV, Inc.

A Veteran Owned Company  
Delivering Freedom

[exhibitorservices@libertycfs.us](mailto:exhibitorservices@libertycfs.us)

[www.libertycfs.us](http://www.libertycfs.us)

Tel. (905) 338-3993 Fax: (905) 338-1092

## FREIGHT & CUSTOMS ORDER FORM

**1** Please accept this form as authority for LibertyCFS NV, Inc. to provide the services listed below. A second form is required for additional events.

Adobe Acrobat Reader DC may be required for completion of form. Click image to download 

Freight & Customs   
  Freight Only   
  Customs Only   
  Return Only

**2a** PICK-UP LOCATION

Company Name \_\_\_\_\_  
 Address1 \_\_\_\_\_  
 Address2 \_\_\_\_\_  
 City \_\_\_\_\_ State \_\_\_\_\_ ZipCode \_\_\_\_\_  
 Contact \_\_\_\_\_ Phone # \_\_\_\_\_  
 Email \_\_\_\_\_ IRS/Tax ID# \_\_\_\_\_

**3** DELIVERY TO ADDRESS

Exhibiting Company Name \_\_\_\_\_ Booth # \_\_\_\_\_  
 Show Name \_\_\_\_\_  
 Address1 \_\_\_\_\_  
 Address2 \_\_\_\_\_  
 City \_\_\_\_\_ State \_\_\_\_\_ ZipCode \_\_\_\_\_  
 Onsite Contact \_\_\_\_\_ Cell Phone # \_\_\_\_\_

**2b** SERVICES

P/U Date \_\_\_\_\_ From \_\_\_\_\_ To \_\_\_\_\_ Hours \_\_\_\_\_  
 DlvY Date \_\_\_\_\_ Hours \_\_\_\_\_

Express   
  Economy LTL 7 - 10 Days   
  Int'l  
 Inside   
  Liftgate   
  Dock  
 Other \_\_\_\_\_

**4** RETURN TO

Check Box if the Return address is the same as 2a

Shipper \_\_\_\_\_  
 Address1 \_\_\_\_\_  
 Address2 \_\_\_\_\_  
 City \_\_\_\_\_ State \_\_\_\_\_ ZipCode \_\_\_\_\_  
 Contact \_\_\_\_\_ Phone # \_\_\_\_\_  
 PU Date \_\_\_\_\_ Arrive by \_\_\_\_\_

**5** PACKAGE INFO

Carton(s)/Box  
 Vinyl Case(s)/Color  
 Wooden Crate(s)  
 Trunk(s) / On Wheels  
 Skid(s) - to contain # \_\_\_\_\_ of pieces

PCS	DIMENSIONS (L x H x W)	WGT
<b>TOTAL PIECES</b>		<b>TOTAL WEIGHT</b>



**6** VALUE

**Declared Value for Carriage:** The declared value for carriage of this shipment is agreed to and understood to be \$0.50 per pound multiplied by the number of pounds of that part of the shipment lost or damaged but not less than \$50.00 per shipment unless a value is declared below and applicable charges paid thereon. The liability of Carrier for loss/damage are subject to the terms and conditions. LibertyCFS NV, Inc charges 4% per \$1000, Min \$40.

**Exclusion: Does not include TV(s)/Monitor(s)**

**DECLARED VALUE** \_\_\_\_\_

**7** PAYMENT

Credit Card Information / Billing Address      

Credit Card Number \_\_\_\_\_ Security Code \_\_\_\_\_ Exp. Date MM / YYY

I hereby authorize the use of this card for payment of services related to this Order Form. I understand that declined credit cards are subject to a 30% surcharge.

Address \_\_\_\_\_ Signature \_\_\_\_\_  
 City \_\_\_\_\_ State \_\_\_\_\_ ZipCode \_\_\_\_\_  
 Phone \_\_\_\_\_ Email \_\_\_\_\_

Comments: Include any additional comments that will be helpful for the movement of freight and contents

**Print**



**Fax: 253 437 0032**  
 14900 Interurban Avenue South, Suite 271  
 Seattle, WA  
 USA 98168  
 Telephone: 253 437 0031  
 E-mail: operations@levyexpo.com

**2023 American Society for Biochemistry and  
 Molecular Biology Annual Meeting (ASBMB)**  
 March 25 - 28, 2023  
 Seattle Convention Center  
 Seattle, WA

**REQUEST FOR SET-UP BY NON-OFFICIAL CONTRACTOR**

The unpacking, erection, assembling, dismantling, and packing of displays and equipment must be done by the correct type of labor. Levy Exposition Services Inc., the official contractor, will have skilled craftsmen available to assist Exhibitors. Arrangements for labor should be made through Levy Exposition Services in advance whenever possible. Official labor forms are included in the Exhibitor Service Manual.

Exceptions to the foregoing will be considered only in cases where permission has been requested in writing by the Exhibitor and **received by Levy Exposition Services Inc. no later than March 3, 2023.** Exceptions will be granted only if it will not interfere with or prejudice the orderly set-up, interim service, or dismantling of the Exposition. An exception will not be granted if it is inconsistent with the commitments made and obligations assumed by Management in any contract with service contractors or its lease with the **Seattle Convention Center** For services such as electrical, plumbing, telephone, drayage, rigging and booth cleaning, no exception will be made, and the contractor designated by Management will be used.

All agents representing the Exhibitor must be fully identified by the official Management badge. All agents or representatives who are performing services other than the Exhibitor's own employees must provide Levy Exposition Services with **Certificates of Insurance naming Levy Exposition Services Inc., ASBMB, SPARGO Inc., 2023 American Society for Biochemistry and Molecular Biology Annual Meeting (ASBMB), and the Seattle Convention Center as additional insured's by March 3, 2023.** These Certificates of Insurance must include public liability and property damage insurance for at least \$1,000,000, and workmen's compensation insurance in accordance with local law.

***Exhibitors wishing to use a contractor other than Levy Exposition Services Inc. to set up and dismantle their exhibits must fill out this form and return to us no later than March 3, 2023. If this form and the certificate of insurance from the non-official contractor is not received by March 3, 2023, your non-official contractor will be allowed to supervise only. All labor must then be hired from Levy Exposition Services Inc. for installation and dismantle of the exhibit.***

**ORIGINAL CERTIFICATES ONLY  
 PHOTOSTATS OR FACSIMILES WILL NOT BE ACCEPTED**

Name of Exhibiting Company: \_\_\_\_\_ Booth Number: \_\_\_\_\_

Contracting Company Name: \_\_\_\_\_

Contracting Company Address: \_\_\_\_\_

City: \_\_\_\_\_ State: \_\_\_\_\_ Zip: \_\_\_\_\_ Telephone: \_\_\_\_\_ Fax \_\_\_\_\_

Estimated Arrival at Show \_\_\_\_\_ Number of Workers: \_\_\_\_\_

Authorized By: \_\_\_\_\_ Title: \_\_\_\_\_  
 (Sign & Print Name)



## ACCESSIBLE STORAGE INFORMATION

Accessible storage will be available to you at this show. You must sign up for the service at the Levy Exposition Services Inc. desk and pick up your accessible storage labels. All freight received at the show will be delivered to your booth space first, and when properly labeled will be placed in accessible storage.

This is not an order form. This service must be ordered on site.

Accessible Storage is **NOT** Secured Storage.

**NOTE:** Accessible Storage items are not necessarily the first items returned to your booth at the close of the show.

Rates are for SET UP, STORAGE SPACE PER DAY, AND EACH TIME ACCESSED, and are as follows:

### **SET UP:**

One time set up charge of \$100.00

### **STORAGE RATES:**

*(RATES ARE PER SQUARE FOOT INCREMENTS OR PORTION THEREOF PER DAY.)*

0 - 25	square feet	\$150.00
26 - 50	square feet	\$200.00
51 - 100	square feet	\$250.00
101 - 150	square feet	\$300.00
151 - 200	square feet	\$350.00

### **ACCESS RATES:**

There is a 1/2 hour labor charge (minimum) each time items are placed into or removed from accessible storage. This charge will be applied at the corresponding rate for the time it is accessed.

### **LABOR RATES:**

<b>STRAIGHT TIME</b>	8:00 AM - 4:30 PM Monday to Friday	\$136.75 per Hour
<b>OVER TIME</b>	4:30 PM - 8:00 AM Monday to Friday, All day Saturday and Sunday	\$205.75 per Hour



2023  
TRADE SHOW  
KIT CATALOG

EFFECTIVE 3.1.2023

# BLANC



**Blanc Sofa**  
Bright White Leather  
75"W x 35"D x 35"H



**Blanc Loveseat**  
Bright White Leather  
54"W x 35"D x 35"H



**Blanc Chair**  
Bright White Leather  
33"W x 35"D x 35"H



**Blanc Bench Ottoman**  
Bright White Leather  
48"W x 24"D x 18"H



**Blanc Cube Ottoman**  
Bright White Leather  
17"Square x 17"H

# WHISPER



**Whisper Sofa**  
White Leather  
87"W x 37"D x 35"H



**Whisper Loveseat**  
White Leather  
61"W x 37"D x 35"H



**Whisper Chair**  
White Leather  
35"W x 37"D x 35"H

# WHISPER



**Whisper Bench Ottoman**

White Leather  
60"W x 24"D x 17"H



**Whisper Square Ottoman**

White Leather  
40"Square x 17"H



**Whisper Round Ottoman**

White Leather  
46"Round x 17"H

# FUNCTION

Modular Seating Collection



**Function Armless Chair**

White Leather  
28"Square x 29"H



**Function Corner**

White Leather  
28"Square x 29"H

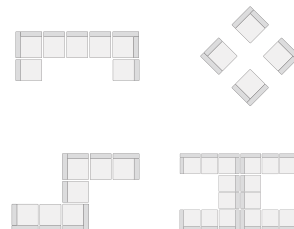

# CONTINENTAL

Modular Seating Collection



**Continental Curved Loveseat**

Bright White Leather  
82"W x 34"D x 31"H



**Continental Reverse Curved Loveseat**

Bright White Leather  
72"W x 34"D x 31"H



**Continental Wedge Ottoman**

Bright White Leather  
30"W x 34"D x 19"H

# CONTINENTAL

Modular Seating Collection



## Continental Curved Bench

Bright White Leather  
70"W x 26"D x 19"H



## Continental Half Moon Ottoman

Bright White Leather  
33"W x 19"D x 19"H

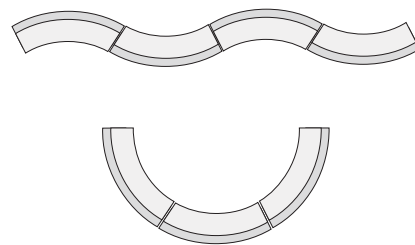

# SOPHISTICATION

Modular Seating Collection



## Sophistication Sofa

White Leather  
72"W x 31"D x 48"H



## Sophistication Loveseat

White Leather  
48"W x 31"D x 48"H



## Sophistication Chair

White Leather  
24"W x 31"D x 48"H



## Sophistication Corner

White Leather  
31"Square x 48"H



## Sophistication Ottoman

White Leather  
31"Square x 19"H

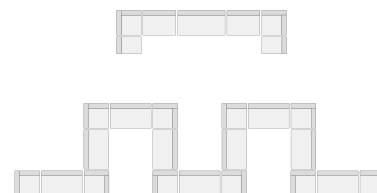

# BOCA

Modular Seating Collection



**Boca Corner**  
Black Leather  
22"W x 27"D x 30"H



**Boca Armless**  
Black Leather  
27"Square x 30"H

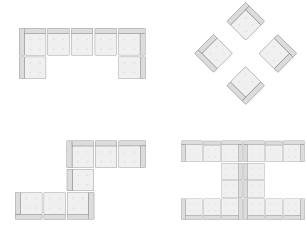

# METRO



**Metro Sofa**  
Black Leather  
85"W x 35"D x 35"H



**Metro Loveseat**  
Black Leather  
60"W x 35"D x 35"H



**Metro Chair**  
Black Leather  
35"Square x 35"H



**Metro Square Ottoman**  
Black Leather  
40"Square x 17"H



**Metro Bench Ottoman**  
Black Leather  
60"W x 24"D x 17"H

# SUAVE MIDNIGHT



## Suave Midnight Sofa

Midnight Suede  
77"W x 36"D x 33"H



## Suave Midnight Loveseat

Midnight Suede  
54"W x 36"D x 33"H



## Suave Midnight Chair

Midnight Suede  
32"W x 36"D x 33"H

# GRAMMERCY

Modular Seating Collection



## Grammercy Sofa

Charcoal Leather  
82"W x 36"D x 36"H



## Grammercy Loveseat

Charcoal Leather  
57"W x 36"D x 36"H



## Grammercy Chair

Charcoal Leather  
28"W x 36"D x 36"H



## Grammercy Corner

Charcoal Leather  
36"Square x 36"H



## Grammercy Round Ottoman

Charcoal Leather  
46"Round x 17"H



## Grammercy Square Ottoman

Charcoal Leather  
40"Square x 17"H  
Also Available in Bench Ottoman  
60"W x 24"D x 17"H

# PARMA



**Parma Sofa**  
Brown Leather  
79"W x 37"D x 36"H



**Parma Loveseat**  
Brown Leather  
56"W x 37"D x 36"H



**Parma Chair**  
Brown Leather  
33"W x 37"D x 36"H



**Parma Bench Ottoman**  
Brown Leather  
60"W x 24"D x 17"H

# MONTANA MOCHA



**Montana Mocha Sofa**  
Mocha Tan Fabric  
79"W x 35"D x 34"H



**Montana Mocha Loveseat**  
Mocha Tan Fabric  
57"W x 35"D x 34"H



**Montana Mocha Chair**  
Mocha Tan Fabric  
35"Square x 34"H



# MADISON



## Madison Sofa

Tan Fabric  
86"W x 34"D x 34"H



## Madison Chair

Tan Fabric  
33"W x 34"D x 34"H



## Madison Sky Bench

Teal Fabric  
48"W x 24"D x 17"H



## Madison Ottoman - Willow

Green Fabric  
24"Square x 17"H



## Madison Ottoman - Sand Dollar

Tan Fabric  
24"Square x 17"H



## Madison Ottoman - Apricot

Orange Fabric  
24"Square x 17"H



## Madison Ottoman - Sunflower

Yellow Fabric  
24"Square x 17"H

## CHANDLER



**Chandler Sofa**

Red Leather  
76"W x 37"D x 35"H



**Chandler Loveseat**

Red Leather  
53"W x 37"D x 35"H



**Chandler Chair**

Red Leather  
31"W x 37"D x 35"H



**Chandler Bench Ottoman**

Red Leather  
60"W x 24"D x 17"H

## EVOKE



**Evoke Sofa**

Coffee Resin Frame with Tan Cushions  
81"W x 35"D x 27"H



**Evoke Chair**

Coffee Resin Frame with Tan Cushions  
33"W x 35"D x 27"H



**Evoke Cocktail Table**

Coffee Resin Frame  
48"W x 24"D x 18"H

# EVOKE



## Evoke End Table

Coffee Resin Frame  
24"W x 28"D x 25"H



## Evoke Cube Table

Coffee Resin Frame  
18"Square x 18"H

# NIKO



## Niko Sofa

Grey Microfiber  
81"W x 30"D x 38"H

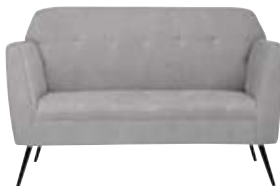

## Niko Loveseat

Grey Microfiber  
58"W x 30"D x 38"H



## Niko Chair

Grey Microfiber  
31"W x 30"D x 38"H

# STAGE CHAIRS



## Midnight Stage Chair

Midnight Microfiber  
25"W x 26"D x 37"H



## Chamois Stage Chair

Beige Microfiber  
25"W x 26"D x 37"H



## Buckskin Stage Chair

Tan Microfiber  
25"W x 26"D x 37"H

## STAGE CHAIRS



**Empire Chair**

Black Leather  
 White Leather  
 28"W x 32"D x 32"H



**Monarch Chair**

Bright White Leather  
 28"Square x 30"H

## OTTOMANS & BENCHES



**Curved Bench**

Continental White Leather  
 70"W x 26"D x 19"H



**Square Ottoman**

Metro Black Leather  
 Whisper White Leather  
 Grammercy Charcoal Leather  
 40"Square x 17"H



**Bench Ottoman**

Metro Black Leather  
 Whisper White Leather  
 Chandler Red Leather  
 Grammercy Charcoal Leather  
 Parma Brown Leather  
 60"W x 24"D x 17"H



**Essentials Storage Ottoman**

White Leather with Locking Mechanism  
 48"W x 24"D x 20"H  
 Lock Not Included



**Round Ottoman**

Grammercy Charcoal Leather  
 Whisper White Leather  
 46"Round x 17"H



**1/4 Round Ottoman**

Grammercy Charcoal Leather  
 Whisper White Leather  
 34"W x 19"D x 17"H

## OTTOMANS & BENCHES



### Madison Sky Bench

Teal Fabric  
48"W x 24"D x 17"H



### Madison Ottomans

Left to Right: Willow, Sand Dollar, Apricot, Sunflower  
24"Square x 17"H

## BANQUETTES



### Essentials Banquette

White Leather  
60"Round x 48"H (2 Pieces)



### Whisper Banquette

White Leather  
59"Round x 38"H (2 Pieces)



### Grammercy Banquette

Charcoal Leather  
59"Round x 38"H (2 Pieces)

## TURNING BEDS



### Essentials Turning Bed

White Leather  
96"W x 48"D x 36"H

# CUBE OTTOMANS



## Rubix Cube Ottomans

- Cherry
  - Cromwell
  - Grape
  - Lemon
  - Lime
  - Mango
- 18"Square x 18"H



### Blanc Cube Ottoman

Bright White Leather  
17"Square x 17"H



### Whisper Cube Ottoman

White Leather  
18"Square x 18"H



### Metro Cube Ottoman

Black Leather  
18"Square x 18"H

**CHARGED!** 



**Essentials Turning Bed - Charged**

White Leather  
96"W x 48"D x 25"H

*\*White slip cover available for black charging unit.  
\*Maximum of 1 bed per power source.*



**Boca Corner - Charged**

Bright White Leather  
27" Square x 30"H

*\*Maximum of 4 daisy linked together per power source.*



**Boca Chair - Charged**

Bright White Leather  
22"W x 27"D x 30"H

*\*Maximum of 4 daisy linked together per power source.*



**Aspen Bar Table - Charged**

White / Brushed Steel  
72"W x 26"D x 42"H

*\*Maximum of 1 table per power source.*



**Aspen Cocktail Table - Charged**

White / Brushed Steel  
48"W x 24"D x 18"H

*\*Maximum of 1 table per power source.*



**White Conference Table - Charged**

White  
96"W x 43"D x 30"H

*\*Maximum of 1 table per power source.*



**Patrice Table Chair - Charged**

Bright White Leather  
28"W x 31"D x 31"H

*\*Maximum of 6 daisy linked together per power source.*



**Lincoln Bench - Charged**

Bright White Leather  
59"W x 39"D x 17"H

*\*Maximum of 3 daisy linked together per power source.*

# OCCASIONAL TABLES



## Tribeca Tables

End Table Wood/Black  
24"W x 28"D x 22"H  
Console Table Wood/Black  
48"W x 18"D x 30"H  
Cocktail Table Wood/Black  
48"W x 28"D x 19"H



## Novel Tables

End Table Satin Steel  
15" Square x 16"H  
Cocktail Table Satin Steel  
46"W x 15"D x 16"H



## Aria Tables Red

End Table Red/Brushed Steel  
24"W x 20"D x 22"H  
Cocktail Table Red/Brushed Steel  
44"W x 20"D x 18"H



## Aria Tables Green

End Table Green/Brushed Steel  
24"W x 20"D x 22"H  
Cocktail Table Green/Brushed Steel  
44"W x 20"D x 18"H



## Aria Tables Blue

End Table Blue/Brushed Steel  
24"W x 20"D x 22"H  
Cocktail Table Blue/Brushed Steel  
44"W x 20"D x 18"H



## Aria Tables Purple

End Table Purple/Brushed Steel  
24"W x 20"D x 22"H  
Cocktail Table Purple/Brushed Steel  
44"W x 20"D x 18"H



## Aria Tables White

End Table White/Brushed Steel  
24"W x 20"D x 22"H  
Console Table White/Brushed Steel  
44"W x 20"D x 30"H  
Cocktail Table White/Brushed Steel  
44"W x 20"D x 18"H



## Aria Tables Charcoal

End Table Storm Grey/Brushed Steel  
24"W x 20"D x 22"H  
Console Table Storm Grey/Brushed Steel  
44"W x 20"D x 30"H  
Cocktail Table Storm Grey/Brushed Steel  
44"W x 20"D x 18"H



# OCCASIONAL TABLES



## Fuze Tables

- End Table Chrome/Zebra wood Laminate  
24" Square x 23"H
- Console Table Chrome/Zebra wood Laminate  
60"W x 16"D x 34"H
- Cocktail Table Chrome/Zebra wood Laminate  
40" Square x 16"H



## London Tables

- End Table Chrome/Marble  
24" Square x 23"H
- Console Table Chrome/Marble  
60"W x 16"D x 34"H
- Cocktail Table Chrome/Marble  
40" Square x 16"H



## Brooklyn Tables

- End Table Square - Chrome  
22" Square x 20"H
- End Table Round - Chrome  
20" Round x 20"H
- Cocktail Table Rectangle - Chrome  
42"W x 24"D x 16"H
- Cocktail Table Round - Chrome  
30" Round x 16"H



## Vivid Tables

- End Table - Smoked Powder Coat Finish  
26" Square x 21"H
- Console Table - Smoked Powder Coat Finish  
50"W x 24"D x 30"H
- Cocktail Table - Smoked Powder Coat Finish  
50"W x 24"D x 16"H



## Rose Table

17" Round x 17"H



## Zanzibar Table

17" Square



## Cube End Tables

- Black 24"
  - White 24"
- 24" Square x 21"H



## Cube Cocktail Tables

- Black 24"
  - White 24"
- 24" Square x 16"H



## Hylton Tablet Table

White/Brushed Steel  
18"W x 12"D x 28"H

# BARS & BAR BACKS



### VIP Glow Bar 6'

Frosted Plexi with Built-in Wireless LED Kit  
 72"W x 24"D x 42"H(Bar)  
 13"D x 18"H (Shelf)  
 \*Includes remote control



### VIP Glow Bar 4'

Frosted Plexi with Built-in Wireless LED Kit  
 48"W x 24"D x 42"H(Bar)  
 13"D x 18"H (Shelf)  
 \*Includes remote control



### Bar

■ Black with 2 shelves in back  
 □ White with 2 shelves in back  
 48"W x 16"D x 42"H



### Blox Bar Back

Walnut/Brushed Metal  
 30"W x 16"D x 86"H  
 Please Inquire About Shelf Dimensions



### Piazza Bar Back

■ Black  
 □ White  
 44"W x 12"D x 79"H  
 13"W x 14"H (Inside Shelf)

# STOOLS



**Vienna Stool**

- Gray Acrylic
  - Orange Acrylic
  - Teal Acrylic
- 17" Square x 39"H



**Criss Cross Bar Stool**

- Espresso Leather
  - White Leather
- 15"W x 19"D x 41"H



**Colin Stool**

- Natural Maple
- 20"W x 19"D x 46"H



**Silk Back Bar Stool**

- Black
  - White
  - Blue
  - Green
  - Purple
  - Red
- 17"W x 18"D x 42"H



**Euro Bar Stool**

- Black
- 22"W x 24"D x 42"H



**Hourglass Bar Stool**

- Black
  - White
- 18"W x 20"D x 43"H



**Equino Stool**

- Black
  - White
- 15"W x 13"D x 35"H

# STOOLS



**Clara Stool**  
White  
17"W x 21"D x 41"H



**Marcus Bar Stool**  
Steel  
17"Square (at footbase) x 29"H



**Regal Stool**  
Brown Leather  
19"W x 24"D x 45"H



**Caprice Stool**  
Black Fabric  
25"W x 26"D x 44"H



**Sonic Stool**  
Black  
22"W x 23"D x 42"H



**Nexus Stool**  
White  
19"W x 20"D x 44"H

# CAFE CHAIRS



**Vienna Chair**  
■ Gray Acrylic  
■ Orange Acrylic  
■ Teal Acrylic  
21"Square x 32"H



**Silk Back Chair**  
■ Black ■ Green  
■ White ■ Purple  
■ Blue ■ Red  
17"W x 18"D x 34"H

# CAFÉ CHAIRS



**Clara Chair**  
White  
18"W x 21"D x 34"H



**Leslie Chair**  
White  
17"W x 21"D x 31"H



**Criss Cross Chair**  
 Espresso Leather  
 White Leather  
 17"W x 21"D x 35"H



**Elio Chair**  
Steel  
17"Square x 33"H



**Caprice Chair**  
Black  
25"W x 24"D x 32"H



**Comet Chair**  
Black  
23"W x 22"D x 32"H (With Arms)  
19"W x 22"D x 32"H (Without Arms)



**Regal Dining Chair**  
Brown Leather  
19"W x 23"D x 38"H



**Sonic Chair**  
Black  
20"W x 21"D x 32"H



**Nexus Chair**  
White  
19"W x 22"D x 32"H

# CAFÉ CHAIRS



**Colin Chair**  
Natural Maple  
22"W x 19"D x 33"H

# BAR TABLES



**Euro Bar Table**  
Black/Black 30"  
30"Round x 42"H  
Black/Black 36"  
36"Round x 42"H



**Silk Bar Table**  
Black/Chrome 30"  
30"Round x 42"H  
Black/Chrome 36"  
36"Round x 42"H



**City Bar Table**  
Maple/Black 30"  
30"Round x 42"H  
Maple/Black 36"  
36"Round x 42"H



**Park Ave Bar Table**  
Maple/Chrome 30"  
30"Round x 42"H  
Maple/Chrome 36"  
36"Round x 42"H



**Summit Bar Table**  
White/Black 30"  
30"Round x 42"H  
White/Black 36"  
36"Round x 42"H



**Blanco Round Bar Table**  
White/Chrome 30"  
30"Round x 42"H  
White/Chrome 36"  
36"Round x 42"H

# BAR TABLES



**Fuze Bar Table**  
Zebrawood Laminate/Chrome  
36"Square x 42"H



**Blanco Square Bar Table**  
White/Chrome  
24"Square x 42"H



**Blanco Rectangle Bar Table**  
White/Chrome  
72"W x 24"D x 42"H



**Spectrum Bar Table Red**  
Red/Chrome  
24"Square x 42"H



**Spectrum Bar Table Blue**  
Blue/Chrome  
24"Square x 42"H



**Spectrum Bar Table Purple**  
Purple/Chrome  
24"Square x 42"H



**Spectrum Bar Table Green**  
Green/Chrome  
24"Square x 42"H



**Zinc Bar Table**  
Chrome  
24"Round x 42"H

## BAR TABLES



### Aspen Bar Table

White/Brushed Steel  
72"W x 26"D x 42"H

## CAFÉ TABLES



### Euro Café Table

Black/Black 30"  
30"Round x 30"H  
Black/Black 36"  
36"Round x 30"H



### Silk Café Table

Black/Chrome 30"  
30"Round x 30"H  
Black/Chrome 36"  
36"Round x 30"H



### Park Ave Café Table

Maple/Chrome 30"  
30"Round x 30"H  
Maple/Chrome 36"  
36"Round x 30"H



### City Café Table

Maple/Black 30"  
30"Round x 30"H  
Maple/Black 36"  
36"Round x 30"H



### Summit Café Table

White/Black 30"  
30"Round x 30"H  
White/Black 36"  
36"Round x 30"H



### Blanco Café Table

White/Chrome 30"  
30"Round x 30"H  
White/Chrome 36"  
36"Round x 30"H



# CAFÉ TABLES



**Fuze Café Table**  
Zebra wood Laminate/Chrome  
36" Square x 30"H



**Blanco Square Café Table**  
White/Chrome Rectangle  
24" Square x 30"H



**Blanco Rectangle Café Table**  
White/Chrome Rectangle  
72"W x 24"D x 30"H



**Spectrum Café Table Red**  
Red/Chrome  
24" Square x 30"H



**Spectrum Café Table Blue**  
Blue/Chrome  
24" Square x 30"H



**Spectrum Café Table Purple**  
Purple/Chrome  
24" Square x 30"H



**Spectrum Café Table Green**  
Green/Chrome  
24" Square x 30"H



**Aspen Dining Table**  
White/Brushed Steel  
72"W x 30"D x 30"H



**Brio Dining Table**  
Reclaimed Grey Stone Finish/Brushed Bronze  
96"W x 48"D x 30"H

# OFFICE SEATING



**Tamiri High Back Chair**

Black Leather  
25"W x 27"D x 45"H



**Tamiri Mid Back Chair**

Black Leather  
25"W x 27"D x 39"H



**Tamiri Guest Chair**

Black Leather  
25"W x 27"D x 37"H



**Accord Chair**

Black  
 White  
 25"Square x 44"H



**Goal Task Chair**

Black  
25"W x 24"D x 39"H



**Goal Task Chair Armless**

Black  
21"W x 24"D x 39"H



**Enterprise High Back Conference Chair**

Black Fabric  
25"W x 27"D x 45"H



**Enterprise Mid Back Conference Chair**

Black Fabric  
24"W x 26"D x 39"H



**Enterprise Guest Chair**

Black Fabric  
25"W x 27"D x 37"H

## OFFICE SEATING



**Goal Drafting Stool**  
 Black  
 25"W x 24"D x 48"H



**Goal Drafting Stool Armless**  
 Black  
 21"W x 24"D x 48"H

## CONFERENCE TABLES



**Conference Table Round**  
 ■ Black  
 ■ Mahogany  
 42"Round x 29"H



**Command 6' Conference Table**  
 ■ Black  
 ■ Sirona  
 □ White  
 72"W x 36"D x 31"H



**Command 8' Conference Table**  
 ■ Black  
 ■ Sirona  
 □ White  
 96"W x 48"D x 31"H



**Command 10' Conference Table**  
 ■ Black  
 ■ Sirona  
 □ White  
 120"W x 48"D x 31"H

# OFFICE FURNITURE



**Computer Kiosk**

Black  
 White  
 24" Square x 42"H



**Black Credenza**

Black  
 60"W x 20"D x 29"H



**Black Double Pedestal Desk**

Black  
 60"W x 30"D x 29"H



**5 Shelf Bookcase**

Black  
 Mahogany  
 36"W x 12"D x 72"H



**Genoa Kneespace Credenza**

Mahogany 2 Filing Cabinets/2-Drawers  
 66"W x 20"D x 29"H



**Genoa Executive Desk**

Mahogany Double Pedestal-Locking Drawers  
 72"W x 36"D x 29"H



**Genoa Storage Credenza**

Mahogany 2 Filing Cabinets  
 2-Drawers-Inside Shelves  
 66"W x 20"D x 29"H

# OFFICE FURNITURE



**Vivid Café Table Square**  
Clear Glass/Smoked Powder Coat Finish  
42"Square x 30"H



**Vivid Café Table Rectangle**  
Clear Glass/Smoked Powder Coat Finish  
60"W x 36"D x 30"H



**Brooklyn Rectangle Dining Table**  
Clear Glass/Chrome  
60"W x 36"D x 30"H



**Brooklyn Round Dining Table**  
Clear Glass/Chrome  
42"Round x 30"H



**Aspen Dining Table**  
White/Brushed Steel  
72"W x 30"D x 30"H



**Brio Dining Table**  
Reclaimed Grey Stone Finish/Brushed Bronze  
96"W x 48"D x 30"H

# METAL FILE & STORAGE CABINETS



## 2-Drawer File

Black Letter  
15"W x 25"D x 29"H

Black Legal  
18"W x 25"D x 29"H



## 4-Drawer File

Black Letter  
15"W x 25"D x 52"H

Black Legal  
18"W x 25"D x 52"H



## 2-Drawer Lateral File

Black (Pictured)  
36"W x 18"D x 27"H

Black (Not Pictured)  
36"W x 20"D x 29"H



## 4-Drawer Lateral File

Black  
36"W x 18"D x 54"H



## Storage Cabinet

Black  
36"W x 18"D x 72"H

# PEDESTALS



## Display Pedestals 42"

- Black  
14"Square x 42"H
- Black  
24"Square x 42"H
- Black  
18"Square x 42"H
- White  
14"Square x 42"H



## Display Pedestals 36"

- Black  
14"Square x 36"H
- Black  
24"Square x 36"H
- White  
14"Square x 36"H
- White  
24"Square x 36"H



## Display Pedestals 30"

- Black  
14"Square x 30"H
- Black  
24"Square x 30"H
- Black  
18"Square x 30"H
- White  
14"Square x 30"H



## Locking Pedestal

- Black  
24"Square x 42"H
- White



## Fuze Pedestal

Zebra wood Laminate/Chrome  
16"Square x 44"H



## London Pedestal

Marble/Chrome  
16"Square x 44"H

# MISCELLANEOUS ITEMS



**Stanchion**  
 Chrome  
 41"H  
**Stanchion Rope**  
 Red Velour  
 6'L



**Nero Literature Rack**  
 Black  
 15"W x 12"D x 54"H



**Argento Literature Rack**  
 Aluminum  
 15"W x 12"D x 54"H



**Alto Literature Rack**  
 Black/Metal  
 11"W x 10"D x 57"H



**Compact Refrigerator**  
 Black 4 Cu Ft  
 21"W x 22"D x 32"H

# LIGHTING



**Silo Grey Lamps**  
 Table Lamp  
 25"H  
 Floor Lamp  
 70"H



**Silo White Lamps**  
 Table Lamp  
 25"H  
 Floor Lamp  
 70"H



**Neutrino Floor Lamp**  
 Steel  
 67"H



# DESIGN YOUR BOOTH SPACE *YOUR WAY*



## 20x20 Booth Footprint

Blanc Loveseat • Blanc Chair • Blanc Cube Ottoman  
 Brooklyn Round End Table • Brooklyn Cocktail Table  
 Aspen Bar Table - Charged • Nexus Stool  
 VIP Glow Bar 6' • Argento Literature Rack



## 20x20 Booth Footprint

Aspen Dining Table • Colin Chair  
 Lincoln Bench - Charged • VIP Glow Bar 4'



## 10x10 Booth Footprint

Niko Chair • Novel End Table • Fuze Pedestal  
 30" Round Bar Table With Tulip Base - White • Vienna Stool



## 20x10 Booth Footprint

Chandler Loveseat • Brushed Steel Lamp  
 Continental Curved Bench • Rose Table  
 Aria End Table - White • London Console Table







# 2023 Trade Show Order Form

AFR Sales Representative: Diana Gonzalez | Angie Carlson

Email/Fax: dgonzalez@rentfurniture.com | acarlson@rentfurniture.com

## TRADE SHOW INFORMATION

Show Name	ASBMB	Company Name			
Show Dates	March 25 - 28, 2023	Onsite Contact Name			
Venue Name	Seattle Convention Center	Onsite Contact Cell #			
Venue Address	705 Pike Street	Delivery Date		Time	
	Seattle, WA 98101	Pickup Date		Time	
Booth # and Name		Show Contractor			

\*\*\*All Furniture Subject to Availability\*\*\*

**Terms & Conditions:** **Payments:** 100% payment due prior to delivery to secure the order unless credit approved with AFR. You may be subject to additional charges by the drayage company for moving the furniture from the loading dock to the exhibit space. Please check your Exhibitor Manual.

**Cancellation Fee:** If cancelled within 3 days prior to delivery, a 100% charge will be applied.

**Late Fee:** All orders received within 14 days of the show opening will receive at 25% late fee. Show site orders will be based on availability and charged a 30% late fee.

**Confirmation:** Please email your sales team if you do not receive confirmation within 1-2 days of submitting this order form.

Item Number	Weight		Dimensions	Standard	Qty.	Total
<b>Blanc (Pg. 2)</b>						
18228-0847	100 lbs.	Blanc Bright White Leather Sofa	75"W x 35"D x 35"H	\$814.00		\$ -
18167-0614	90 lbs.	Blanc Bright White Leather Loveseat	54"W x 35"D x 35"H	\$777.00		\$ -
18284-0834	75 lbs.	Blanc Bright White Leather Chair	33"W x 35"D x 35"H	\$649.00		\$ -
18024-0072	40 lbs.	Blanc Bright White Leather Bench Ottoman	48"W x 24"D x 18"H	\$390.00		\$ -
18184-0274	15 lbs.	Blanc Bright White Leather Cube Ottoman	17"Square	\$136.00		\$ -
<b>Whisper (Pg. 2 &amp; 3)</b>						
18228-0607	115 lbs.	Whisper White Leather Sofa	87"W x 37"D x 35"H	\$777.00		\$ -
18167-0471	90 lbs.	Whisper White Leather Loveseat	61"W x 37"D x 35"H	\$745.00		\$ -
18284-0487	60 lbs.	Whisper White Leather Chair	35"W x 37"D x 35"H	\$618.00		\$ -
18024-0003	43 lbs.	Whisper White Leather Bench Ottoman	60"W x 24"D x 17"H	\$345.00		\$ -
18184-0034	65 lbs.	Whisper White Leather Square Ottoman	40"Square x 17"H	\$345.00		\$ -
18184-0038	64 lbs.	Whisper White Leather Round Ottoman	46"Round x 17"H	\$345.00		\$ -
<b>Function (Pg. 3)</b>						
18284-0554	38 lbs.	Function Bright White Leather Armless Chair	28"Square x 29"H	\$415.00		\$ -
18066-0016	27 lbs.	Function Bright White Leather Corner	28"Square x 29"H	\$446.00		\$ -
<b>Continental (Pg. 3 &amp; 4)</b>						
18303-0006	105 lbs.	Continental Bright White Leather Curved Loveseat	82"W x 34"D x 31"H	\$802.00		\$ -
18304-0002	105 lbs.	Continental Bright White Leather Reverse Curved Loveseat	72"W x 34"D x 31"H	\$777.00		\$ -
18296-0006	35 lbs.	Continental Bright White Leather Wedge Ottoman	30"W x 34"D x 19"H	\$345.00		\$ -
18184-0283	75 lbs.	Continental Bright White Leather Curved Bench	70"W x 26"D x 19"H	\$407.00		\$ -
18184-0284	30 lbs.	Continental Bright White Leather Half Moon Ottoman	33"W x 19"D x 19"H	\$345.00		\$ -
<b>Sophistication (Pg. 4)</b>						
18228-0674	100 lbs.	Sophistication White Leather Sofa	72"W x 31"D x 48"H	\$802.00		\$ -
18167-0466	90 lbs.	Sophistication White Leather Loveseat	48"W x 31"D x 48"H	\$542.00		\$ -
18284-0563	60 lbs.	Sophistication White Leather Chair	27"W x 31"D x 48"H	\$407.00		\$ -
18066-0017	60 lbs.	Sophistication White Leather Corner	31"Square x 48"H	\$407.00		\$ -
18184-0130	40 lbs.	Sophistication White Leather Ottoman	31"Square x 19"H	\$306.00		\$ -
<b>Boca (Pg. 5)</b>						
18066-0026	38 lbs.	Boca Black Leather Corner	27"W x 27"D x 30"H	\$446.00		\$ -
18284-0786	28 lbs.	Boca Black Leather Armless	22"W x 27"D x 30"H	\$415.00		\$ -
<b>Metro (Pg. 5)</b>						
18228-0602	110 lbs.	Metro Black Leather Sofa	85"W x 35"D x 35"H	\$669.00		\$ -
18167-0467	90 lbs.	Metro Black Leather Loveseat	60"W x 35"D x 35"H	\$644.00		\$ -
18284-0482	75 lbs.	Metro Black Leather Chair	35"Square x 35"H	\$503.00		\$ -
18184-0179	65 lbs.	Metro Black Leather Square Ottoman	40"Square x 17"H	\$345.00		\$ -
18024-0008	43 lbs.	Metro Black Leather Bench Ottoman	60"W x 24"D x 17"H	\$345.00		\$ -
<b>Suave Midnight (Pg. 6)</b>						
18228-0085	105 lbs.	Suave Midnight Sofa	77"W x 36"D x 33"H	\$586.00		\$ -
18167-0069	80 lbs.	Suave Midnight Loveseat	54"W x 36"D x 33"H	\$509.00		\$ -
18284-0151	65 lbs.	Suave Midnight Chair	32"W x 36"D x 33"H	\$382.00		\$ -
<b>Grammercy (Pg. 6)</b>						
18228-0605	90 lbs.	Grammercy Charcoal Leather Sofa	82"W x 36"D x 36"H	\$745.00		\$ -
18167-0469	90 lbs.	Grammercy Charcoal Leather Loveseat	57"W x 36"D x 36"H	\$649.00		\$ -
18284-0485	40 lbs.	Grammercy Charcoal Leather Chair	28"W x 36"D x 36"H	\$415.00		\$ -
18066-0015	51 lbs.	Grammercy Charcoal Leather Corner	36"Square x 36"H	\$478.00		\$ -
18184-0036	64 lbs.	Grammercy Charcoal Leather Round Ottoman	46"Round x 17"H	\$345.00		\$ -
18184-0033	65 lbs.	Grammercy Charcoal Leather Square Ottoman	40"Square x 17"H	\$345.00		\$ -
<b>Parma (Pg. 7)</b>						
18228-0789	100 lbs.	Parma Brown Leather Sofa	79"W x 37"D x 36"H	\$669.00		\$ -
18167-0577	90 lbs.	Parma Brown Leather Loveseat	56"W x 37"D x 36"H	\$644.00		\$ -
18284-0710	75 lbs.	Parma Brown Leather Chair	33"W x 37"D x 36"H	\$503.00		\$ -
18024-0061	43 lbs.	Parma Brown Leather Bench Ottoman	60"W x 24"D x 17"H	\$345.00		\$ -
<b>Montana Mocha (Pg. 7)</b>						
18228-0784	100 lbs.	Montana Mocha Sofa	79"W x 35"D x 34"H	\$630.00		\$ -
18167-0573	90 lbs.	Montana Mocha Loveseat	57"W x 35"D x 34"H	\$554.00		\$ -
18284-0704	75 lbs.	Montana Mocha Chair	35"Square x 34"H	\$427.00		\$ -
<b>Madison (Pg. 8)</b>						
18228-0823	100 lbs.	Madison Sofa	86"W x 34"D x 34"H	\$777.00		\$ -
18284-0794	75 lbs.	Madison Chair	33"W x 34"D x 34"H	\$453.00		\$ -

18184-0256	35 lbs.	Madison Sky Bench	4"W x 24"D x 17"H	\$319.00		\$	-
18184-0252	20 lbs.	Madison Ottoman - Willow	24"Square x 17"H	\$204.00		\$	-
18184-0253	20 lbs.	Madison Ottoman - Sand Dollar	24"Square x 17"H	\$204.00		\$	-
18184-0254	20 lbs.	Madison Ottoman - Apricot	24"Square x 17"H	\$204.00		\$	-
18184-0255	20 lbs.	Madison Ottoman - Sunflower	24"Square x 17"H	\$204.00		\$	-
<b>Chandler (Pg. 9)</b>							
18228-0795	100 lbs.	Chandler Red Leather Sofa	76"W x 37"D x 35"H	\$669.00		\$	-
18167-0581	90 lbs.	Chandler Red Leather Loveseat	53"W x 37"D x 35"H	\$644.00		\$	-
18284-0717	75 lbs.	Chandler Red Leather Chair	31"W x 37"D x 35"H	\$503.00		\$	-
18024-0062	43 lbs.	Chandler Red Leather Bench Ottoman	60"W x 24"D x 17"H	\$345.00		\$	-
<b>Evoke (Pg. 9 &amp; 10)</b>							
13229-0007	80 lbs.	Evoke Sofa	81"W x 35"D x 27"H	\$1,011.00		\$	-
13041-0015	40 lbs.	Evoke Chair	33"W x 35"D x 27"H	\$542.00		\$	-
13054-0011	20 lbs.	Evoke Cocktail Table	48"W x 24"D x 18"H	\$345.00		\$	-
13110-0009	20 lbs.	Evoke End Table	24"W x 28"D x 25"H	\$306.00		\$	-
13110-0008	10 lbs.	Evoke Cube Table	18"Square	\$217.00		\$	-
<b>Niko (Pg. 10)</b>							
18228-0858	100 lbs.	Niko Sofa	81"W x 30"D x 38"H	\$828.00		\$	-
18167-0622	85 lbs.	Niko Loveseat	58"W x 30"D x 38"H	\$757.00		\$	-
18284-0856	70 lbs.	Niko Chair	31"W x 30"D x 38"H	\$630.00		\$	-
<b>Stage Chairs (Pg. 10 &amp; 11)</b>							
18284-0478	29 lbs.	Midnight Stage Chair	25"W x 26"D x 37"H	\$249.00		\$	-
18284-0477	29 lbs.	Chamois Stage Chair	25"W x 26"D x 37"H	\$249.00		\$	-
18284-0476	29 lbs.	Buckskin Stage Chair	25"W x 26"D x 37"H	\$249.00		\$	-
18284-0621	80 lbs.	Empire Chair - Black Leather	28"W x 32"D x 32"H	\$446.00		\$	-
18284-0564	80 lbs.	Empire Chair - White Leather	28"W x 32"D x 32"H	\$446.00		\$	-
18284-0785	24 lbs.	Monarch Chair	28"Square x 30"H	\$285.00		\$	-
<b>Ottomans &amp; Benches (Pg. 11 &amp; 12)</b>							
18184-0283	75 lbs.	Continental Bright White Leather Curved Bench	70"W x 26"D x 19"H	\$407.00		\$	-
18184-0179	65 lbs.	Metro Black Leather Square Ottoman	40"Square x 17"H	\$345.00		\$	-
18184-0034	65 lbs.	Whisper White Leather Square Ottoman	40"Square x 17"H	\$345.00		\$	-
18184-0033	65 lbs.	Grammercy Charcoal Leather Square Ottoman	40"Square x 17"H	\$345.00		\$	-
18024-0008	43 lbs.	Metro Black Leather Bench Ottoman	60"W x 24"D x 17"H	\$345.00		\$	-
18024-0003	43 lbs.	Whisper White Leather Bench Ottoman	60"W x 24"D x 17"H	\$345.00		\$	-
18024-0062	43 lbs.	Chandler Red Leather Bench Ottoman	60"W x 24"D x 17"H	\$345.00		\$	-
18024-0002	43 lbs.	Grammercy Charcoal Leather Bench Ottoman	60"W x 24"D x 17"H	\$345.00		\$	-
18024-0061	43 lbs.	Parma Brown Leather Bench Ottoman	60"W x 24"D x 17"H	\$345.00		\$	-
18184-0192	70 lbs.	Essentials Storage Ottoman	48"W x 24"D x 20"H	\$478.00		\$	-
18184-0036	64 lbs.	Grammercy Charcoal Leather Round Ottoman	46"Round x 17"H	\$345.00		\$	-
18184-0038	64 lbs.	Whisper White Leather Round Ottoman	46"Round x 17"H	\$345.00		\$	-
18184-0028	15 lbs.	Grammercy Charcoal Leather 1/4 Round Ottoman	34"W x 19"D x 17"H	\$212.00		\$	-
18184-0030	15 lbs.	Whisper White Leather White 1/4 Round Ottoman	34"W x 19"D x 17"H	\$212.00		\$	-
18184-0256	35 lbs.	Madison Sky Bench	4"W x 24"D x 17"H	\$319.00		\$	-
18184-0252	20 lbs.	Madison Ottoman - Willow	24"Square x 17"H	\$204.00		\$	-
18184-0253	20 lbs.	Madison Ottoman - Sand Dollar	24"Square x 17"H	\$204.00		\$	-
18184-0254	20 lbs.	Madison Ottoman - Apricot	24"Square x 17"H	\$204.00		\$	-
18184-0255	20 lbs.	Madison Ottoman - Sunflower	24"Square x 17"H	\$204.00		\$	-
<b>Banquettes &amp; Turning Beds (Pg. 12)</b>							
18011-0011	185 lbs.	Essentials White Leather Banquette (2 pcs)	60"Round x 48"H	\$1,011.00		\$	-
18011-0001	130 lbs.	Whisper White Leather Banquette (2 pcs)	59"Round x 38"H	\$1,011.00		\$	-
18011-0002	130 lbs.	Grammercy Charcoal Leather Banquette (2 pcs)	59"Round x 38"H	\$1,011.00		\$	-
02082-0033	200 lbs.	Essentials White Leather Turning Bed	96"W x 48"D x 34"H	\$1,215.00		\$	-
<b>Cube Ottomans (Pg. 13)</b>							
18184-0294	10 lbs.	Rubix Cube - Cherry	17"Square x 18"H	\$139.00		\$	-
18184-0295	10 lbs.	Rubix Cube - Cromwell	17"Square x 18"H	\$139.00		\$	-
18184-0296	10 lbs.	Rubix Cube - Grape	17"Square x 18"H	\$139.00		\$	-
18184-0293	10 lbs.	Rubix Cube - Lemon	17"Square x 18"H	\$139.00		\$	-
18184-0297	10 lbs.	Rubix Cube - Lime	17"Square x 18"H	\$139.00		\$	-
18184-0298	10 lbs.	Rubix Cube - Mango	17"Square x 18"H	\$139.00		\$	-
18184-0274	15 lbs.	Blanc Bright White Leather Cube	17"Square x 17"H	\$136.00		\$	-
18184-0129	15 lbs.	Whisper White Leather Cube Ottoman	18"Square x 18"H	\$136.00		\$	-
18184-0128	15 lbs.	Metro Black Leather Cube Ottoman	18"Square x 18"H	\$136.00		\$	-
<b>Charged (Pg. 14)</b>							
22100-0001	192 lbs.	Essentials Turning Bed w/Charging Station Insert	96"W x 48"D x 19"H	\$1,348.00		\$	-
22051-0001	40 lbs.	Boca Bright White Corner - Charged	27"W x 27"D x 30"H	\$509.00		\$	-
22050-0001	40 lbs.	Boca Bright White Armless - Charged	22"W x 27"D x 30"H	\$471.00		\$	-
22001-0001	80 lbs.	Aspen Bar Table - Charged	72"W x 26"D x 42"H	\$789.00		\$	-
22002-0002	55 lbs.	Aspen Cocktail Table - Charged	48"W x 24"D x 18"H	\$446.00		\$	-
22200-0001	230 lbs.	White Conference Table - Charged	96"W x 43"D x 30"H	\$1,062.00		\$	-
18284-0861	52 lbs.	Patrice Tablet Chair	28"W x 30.5"D x 31"H	\$491.00		\$	-
22052-0001	60 lbs.	Lincoln Bench - Charged	59"W x 39"D x 17"H	\$745.00		\$	-
<b>Occasional Tables (Pg. 15 &amp; 16)</b>							
12107-0008	30 lbs.	Tribeca End Table	24"W x 28"D x 22"H	\$242.00		\$	-
12230-0005	40 lbs.	Tribeca Console Table	48"W x 18"D x 30"H	\$269.00		\$	-
12055-0008	50 lbs.	Tribeca Cocktail Table	48"W x 28"D x 19"H	\$255.00		\$	-
18024-0010	30 lbs.	Novel End Table	15"Square x 16"H	\$306.00		\$	-
18024-0011	50 lbs.	Novel Cocktail Table	46"W x 15"D x 16"H	\$345.00		\$	-
99-12304-05	10 lbs.	Aria Red End Table	24"W x 20"D x 22"H	\$242.00		\$	-
99-12050-05	20 lbs.	Aria Red Cocktail Table	44"W x 20"D x 18"H	\$255.00		\$	-
99-12304-03	10 lbs.	Aria Green End Table	24"W x 20"D x 22"H	\$242.00		\$	-
99-12050-03	20 lbs.	Aria Green Cocktail Table	44"W x 20"D x 18"H	\$255.00		\$	-
99-12304-06	10 lbs.	Aria Blue End Table	24"W x 20"D x 22"H	\$242.00		\$	-

99-12050-06	20 lbs.	Aria Blue Cocktail Table	44"W x 20"D x 18"H	\$255.00		\$	-
99-12304-04	10 lbs.	Aria Purple End Table	24"W x 20"D x 22"H	\$242.00		\$	-
99-12050-04	20 lbs.	Aria Purple Cocktail Table	44"W x 20"D x 18"H	\$255.00		\$	-
99-12304-01	10 lbs.	Aria White End Table	24"W x 20"D x 22"H	\$242.00		\$	-
99-12305-01	35 lbs.	Aria White Console Table	44"W x 20"D x 30"H	\$269.00		\$	-
99-12050-01	20 lbs.	Aria White Cocktail Table	44"W x 20"D x 18"H	\$255.00		\$	-
99-12304-02	10 lbs.	Aria Charcoal End Table	24"W x 20"D x 22"H	\$242.00		\$	-
99-12305-02	35 lbs.	Aria Charcoal Console Table	44"W x 20"D x 30"H	\$269.00		\$	-
99-12050-02	20 lbs.	Aria Charcoal Cocktail Table	44"W x 20"D x 18"H	\$255.00		\$	-
12107-0512	27 lbs.	Fuze End Table	24"Square x 23"H	\$262.00		\$	-
12230-0116	49 lbs.	Fuze Console Table	60"W x 16"D x 34"H	\$319.00		\$	-
12055-0453	55 lbs.	Fuze Cocktail Table	40"Square x 16"H	\$294.00		\$	-
12107-0493	27 lbs.	London End Table	24"Square x 23"H	\$262.00		\$	-
12230-0110	49 lbs.	London Console Table	60"W x 16"D x 34"H	\$319.00		\$	-
12055-0428	55 lbs.	London Cocktail Table	40"Square x 16"H	\$294.00		\$	-
12107-0494	21 lbs.	Brooklyn II Square End Table	22"W X 22"D X 20"H	\$224.00		\$	-
12107-0495	15 lbs.	Brooklyn II Round End Table	20"Round X 20"H	\$224.00		\$	-
12055-0429	35 lbs.	Brooklyn II Rect Cocktail Table	42"W X 24"D X 16"H	\$249.00		\$	-
12055-0430	25 lbs.	Brooklyn II Round Cocktail Table	30"Round X 16"H	\$249.00		\$	-
12107-0282	35 lbs.	Vivid End Table	26"Square x 21"H	\$242.00		\$	-
12230-0081	62 lbs.	Vivid Console Table	50"W x 24"D x 30"H	\$269.00		\$	-
12055-0273	50 lbs.	Vivid Cocktail Table	50"W x 24"D x 16"H	\$255.00		\$	-
12003-0038	15 lbs.	Rose Table	17"Round x 17"H	\$269.00		\$	-
12003-0039	20 lbs.	Zanzibar Table	17"Square	\$269.00		\$	-
12107-0296	50 lbs.	24" Cube End Table - Black	24"Square x 21"H	\$249.00		\$	-
12107-0297	55 lbs.	24" Cube End Table - White	24"Square x 21"H	\$249.00		\$	-
12055-0285	40 lbs.	24" Cube Cocktail Table - Black	24"Square x 16"H	\$242.00		\$	-
12055-0286	40 lbs.	24" Cube Cocktail Table - White	24"Square x 16"H	\$242.00		\$	-
12107-0467	13 lbs.	Hylton Tablet Table	18"W x 12"D x 28"H	\$217.00		\$	-
<b>Bars &amp; Bar Backs (Pg. 17)</b>							
05012-0076	185 lbs.	VIP Glow Bar 6'	72"W x 24"D x 42"H	\$884.00		\$	-
05012-0075	130 lbs.	VIP Glow Bar 4'	48"W x 24"D x 42"H	\$745.00		\$	-
05012-0053	70 lbs.	Black Bar - 2 Shelf	48"W x 16"D x 42"H	\$407.00		\$	-
05012-0054	70 lbs.	White Bar - 2 Shelf	48"W x 16"D x 42"H	\$407.00		\$	-
12112-0010	60 lbs.	Blox Bar Back	30"W x 16"D x 86"H	\$509.00		\$	-
05001-0017	150 lbs.	Piazza Bar Back - Black	44"W x 12"D x 80"H	\$478.00		\$	-
05001-0018	150 lbs.	Piazza Bar Back - White	44"W x 12"D x 80"H	\$478.00		\$	-
<b>Bar Stools (Pg. 18 &amp; 19)</b>							
05237-0264	15 lbs.	Vienna Stool - Gray	17"Square x 39"H	\$255.00		\$	-
05237-0263	15 lbs.	Vienna Stool - Orange	17"Square x 39"H	\$255.00		\$	-
05237-0262	15 lbs.	Vienna Stool - Teal	17"Square x 39"H	\$255.00		\$	-
05237-0038	15 lbs.	Criss Cross Bar Stool - Espresso	15"W x 19"D x 41"H	\$229.00		\$	-
05237-0039	15 lbs.	Criss Cross Bar Stool - White	15"W x 19"D x 41"H	\$229.00		\$	-
05237-0305	17 lbs.	Colin Stool	20"W x 19"D x 46"H	\$192.00		\$	-
99-05237-01	20 lbs.	Silk Back Bar Stool - Black	17"W x 18"D x 42"H	\$217.00		\$	-
99-05237-02	20 lbs.	Silk Back Bar Stool - White	17"W x 18"D x 42"H	\$217.00		\$	-
99-05237-06	20 lbs.	Silk Back Bar Stool - Blue	17"W x 18"D x 42"H	\$217.00		\$	-
99-05237-03	20 lbs.	Silk Back Bar Stool - Green	17"W x 18"D x 42"H	\$217.00		\$	-
99-05237-04	20 lbs.	Silk Back Bar Stool - Purple	17"W x 18"D x 42"H	\$217.00		\$	-
99-05237-05	20 lbs.	Silk Back Bar Stool - Red	17"W x 18"D x 42"H	\$217.00		\$	-
05237-0221	20 lbs.	Euro Bar Stool - Black	22"W x 24"D x 42"H	\$217.00		\$	-
05237-0270	40 lbs.	Hourglass Bar Stool - Black	18"W x 20"D x 43"H	\$237.00		\$	-
05237-0271	40 lbs.	Hourglass Bar Stool - White	18"W x 20"D x 43"H	\$237.00		\$	-
05237-0160	35 lbs.	Equino Bar Stool - Black	15"W x 13"D x 35"H	\$237.00		\$	-
05237-0041	35 lbs.	Equino Bar Stool - White	15"W x 13"D x 35"H	\$237.00		\$	-
05237-0298	16 lbs.	Clara Stool	17"W x 21"D x 41"H	\$229.00		\$	-
05237-0215	15 lbs.	Marcus Stool	18"Square x 29"H	\$173.00		\$	-
05237-0156	20 lbs.	Regal Stool	19"W x 24"D x 45"H	\$237.00		\$	-
05237-0169	25 lbs.	Caprice Stool	25"W x 26"D x 44"H	\$237.00		\$	-
05237-0042	15 lbs.	Sonic Stool	22"W x 23"D x 42"H	\$192.00		\$	-
05237-0300	6 lbs.	Nexus Stool	19"W x 20"D x 44"H	\$198.00		\$	-
<b>Café Chairs (Pg. 19, 20, &amp; 21)</b>							
05035-0032	15 lbs.	Vienna Chair - Gray	21"Square x 32"H	\$161.00		\$	-
05035-0031	15 lbs.	Vienna Chair - Orange	21"Square x 32"H	\$161.00		\$	-
05035-0030	15 lbs.	Vienna Chair - Teal	21"Square x 32"H	\$161.00		\$	-
99-05035-10	20 lbs.	Silk Back Armless Chair - Black	17"W x 18"D x 34"H	\$136.00		\$	-
99-05035-11	20 lbs.	Silk Back Armless Chair - White	17"W x 18"D x 34"H	\$136.00		\$	-
99-05035-15	20 lbs.	Silk Back Armless Chair - Blue	17"W x 18"D x 34"H	\$136.00		\$	-
99-05035-12	20 lbs.	Silk Back Armless Chair - Green	17"W x 18"D x 34"H	\$136.00		\$	-
99-05035-13	20 lbs.	Silk Back Armless Chair - Purple	17"W x 18"D x 34"H	\$136.00		\$	-
99-05035-14	20 lbs.	Silk Back Armless Chair - Red	17"W x 18"D x 34"H	\$136.00		\$	-
05035-0051	11 lbs.	Clara Chair	18"W x 21"D x 35"H	\$153.00		\$	-
05035-0008	10 lbs.	Leslie Chair	17"W x 21"D x 31"H	\$121.00		\$	-
05035-0010	15 lbs.	Criss Cross Chair - Espresso	17"W x 21"D x 35"H	\$153.00		\$	-
05035-0011	15 lbs.	Criss Cross Chair - White	17"W x 21"D x 35"H	\$153.00		\$	-
05035-0023	24 lbs.	Elio Chair	17"Square x 33"H	\$136.00		\$	-
14233-0025	20 lbs.	Caprice Chair - Black	25"W x 24"D x 32"H	\$136.00		\$	-
14233-0005	20 lbs.	Comet Stack Chair - Arms	23"W x 22"D x 32"H	\$186.00		\$	-
14233-0006	15 lbs.	Comet Stack Chair - Armless	19"W x 22"D x 32"H	\$173.00		\$	-
05221-0039	20 lbs.	Regal Dining Chair	19"W x 23"D x 38"H	\$192.00		\$	-
14233-0016	10 lbs.	Sonic Chair	20"W x 21"D x 32"H	\$136.00		\$	-
05035-0050	5 lbs.	Nexus Chair	19"W x 22"D x 32"H	\$161.00		\$	-

05035-0052	12 lbs.	Colin Chair	22"W x 19"D x 33"H	\$136.00		\$	-
<b>Bar Tables (Pg. 21, 22, &amp; 23)</b>							
99-05245-01	34 lbs.	Euro Bar Table Black/Black 30" Round	30"Round x 42"H	\$242.00		\$	-
99-05245-02	41 lbs.	Euro Bar Table Black/Black 36" Round	36"Round x 42"H	\$249.00		\$	-
99-05245-04	30 lbs.	Silk Bar Table Black/Chrome 30" Round	30"Round x 42"H	\$242.00		\$	-
99-05245-05	37 lbs.	Silk Bar Table Black/Chrome 36" Round	36"Round x 42"H	\$249.00		\$	-
99-05245-14	34 lbs.	City Bar Table Maple/Black 30" Round	30"Round x 42"H	\$242.00		\$	-
99-05245-15	41 lbs.	City Bar Table Maple/Black 36" Round	36"Round x 42"H	\$249.00		\$	-
99-05245-07	30 lbs.	Park Ave Bar Table Maple/Chrome 30" Round	30"Round x 42"H	\$242.00		\$	-
99-05245-08	37 lbs.	Park Ave Bar Table Maple/Chrome 36" Round	36"Round x 42"H	\$249.00		\$	-
99-05245-16	34 lbs.	Summit Bar Table White/Black 30" Round	30"Round x 42"H	\$242.00		\$	-
99-05245-17	41 lbs.	Summit Bar Table White/Black 36" Round	36"Round x 42"H	\$249.00		\$	-
99-05245-10	30 lbs.	Blanco Bar Table White/Chrome 30" Round	30"Round x 42"H	\$242.00		\$	-
99-05245-11	37 lbs.	Blanco Bar Table White/Chrome 36" Round	36"Round x 42"H	\$249.00		\$	-
99-05245-22	43 lbs.	Fuze Bar Table	36"Square x 42"H	\$274.00		\$	-
99-05245-12	28 lbs.	Blanco Bar Table - White/Chrome 24"Square	24"Square x 42"H	\$242.00		\$	-
99-05245-13	69 lbs.	Blanco Rectangle Bar Table - White/Chrome	72"W x 24"D x 42"H	\$376.00		\$	-
99-05245-20	28 lbs.	Spectrum Bar Table - Red	24"Square x 42"H	\$262.00		\$	-
99-05245-21	28 lbs.	Spectrum Bar Table - Blue	24"Square x 42"H	\$262.00		\$	-
99-05245-18	28 lbs.	Spectrum Bar Table - Purple	24"Square x 42"H	\$262.00		\$	-
99-05245-19	28 lbs.	Spectrum Bar Table - Green	24"Square x 42"H	\$262.00		\$	-
05202-0049	50 lbs.	Zinc Bar Table	24"Round x 42"H	\$363.00		\$	-
05204-0001	75 lbs.	Aspen Bar Table	72"W x 26"D x 42"H	\$675.00		\$	-
<b>Café Tables (Pg. 23 &amp; 24)</b>							
99-05036-01	30 lbs.	Euro Café Table Black/Black 30" Round	30"Round x 30"H	\$242.00		\$	-
99-05036-02	37 lbs.	Euro Café Table Black/Black 36" Round	36"Round x 30"H	\$249.00		\$	-
99-05036-04	27 lbs.	Silk Café Table Black/Chrome 30" Round	30"Round x 30"H	\$242.00		\$	-
99-05036-05	34 lbs.	Silk Café Table Black/Chrome 36" Round	36"Round x 30"H	\$249.00		\$	-
99-05036-07	27 lbs.	Park Ave Café Table Maple/Chrome 30" Round	30"Round x 30"H	\$242.00		\$	-
99-05036-08	34 lbs.	Park Ave Café Table Maple/Chrome 36" Round	36"Round x 30"H	\$249.00		\$	-
99-05036-14	30 lbs.	City Café Table Maple/Black 30" Round	30"Round x 30"H	\$242.00		\$	-
99-05036-15	37 lbs.	City Café Table Maple/Black 36" Round	36"Round x 30"H	\$249.00		\$	-
99-05036-16	30 lbs.	Summit Café Table White/Black 30" Round	30"Round x 30"H	\$242.00		\$	-
99-05036-17	37 lbs.	Summit Café Table White/Black 36" Round	36"Round x 30"H	\$249.00		\$	-
99-05036-10	27 lbs.	Blanco Café Table White/Chrome 30" Round	30"Round x 30"H	\$242.00		\$	-
99-05036-11	34 lbs.	Blanco Café Table White/Chrome 36" Round	36"Round x 30"H	\$249.00		\$	-
99-05036-22	40 lbs.	Fuze Café Table	36"Square x 30	\$274.00		\$	-
99-05036-12	25 lbs.	Blanco Café Table White/Chrome 24"Square	24"Square x 30"H	\$242.00		\$	-
99-05036-13	63 lbs.	Blanco Café Table White/Chrome Rectangle	72"W x 24"D x 30"H	\$376.00		\$	-
99-05036-20	25 lbs.	Spectrum Café Table - Red	24"Square x 29"H	\$262.00		\$	-
99-05036-21	25 lbs.	Spectrum Café Table - Blue	24"Square x 29"H	\$262.00		\$	-
99-05036-18	25 lbs.	Spectrum Café Table - Purple	24"Square x 29"H	\$262.00		\$	-
99-05036-19	25 lbs.	Spectrum Café Table - Green	24"Square x 29"H	\$262.00		\$	-
05090-0001	90 lbs.	Aspen Dining Table	72"W x 30"D x 30"H	\$579.00		\$	-
05088-0505	200 lbs.	Brio Dining Table	96"W x 48"D x 30"H	\$777.00		\$	-
<b>Office Seating (Pg. 25 &amp; 26)</b>							
14136-0002	38 lbs.	Tamiri High Back Chair	25"W x 27"D x 45"H	\$306.00		\$	-
14176-0007	37 lbs.	Tamiri Mid Back Chair	27"Square x 39"H	\$269.00		\$	-
14128-0002	41 lbs.	Tamiri Guest Chair	25"W x 26"D x 37"H	\$249.00		\$	-
14136-0081	40 lbs.	Accord High Back Chair - Black	25"Square x 44"H	\$382.00		\$	-
14136-0010	40 lbs.	Accord High Back Chair - White	25"Square x 44"H	\$382.00		\$	-
14250-0013	36 lbs.	Goal Task Chair - Arms	25"Square x 39"H	\$204.00		\$	-
14250-0014	38 lbs.	Goal Task Chair Armless	21"W x 25"D x 39"H	\$186.00		\$	-
14136-0080	40 lbs.	Enterprise High Back Conference Chair	25"W x 27"D x 45"H	\$269.00		\$	-
14176-0046	35 lbs.	Enterprise Mid Back Conference Chair	24"W x 26"D x 39"H	\$249.00		\$	-
14128-0096	33 lbs.	Enterprise Guest Chair	25"W x 27"D x 37"H	\$229.00		\$	-
14307-0003	36 lbs.	Goal Black Drafting Stool - Arms	25"W x 24"D x 48"H	\$217.00		\$	-
14307-0004	30 lbs.	Goal Black Drafting Stool - Armless	21"W x 24"D x 48"H	\$204.00		\$	-
<b>Conference Tables (Pg. 26)</b>							
14062-0105	97 lbs.	42" Round Conference Table - Black	42" Round x 29"H	\$338.00		\$	-
14062-0106	97 lbs.	42" Round Conference Table - Mahogany	42" Round x 29"H	\$338.00		\$	-
14062-0297	90 lbs.	Command Conference Table - 6' Black	72"W x 36"D x 31"H	\$604.00		\$	-
14062-0303	90 lbs.	Command Conference Table - 6' Sirona	72"W x 36"D x 31"H	\$604.00		\$	-
14062-0300	90 lbs.	Command Conference Table - 6' White	72"W x 36"D x 31"H	\$604.00		\$	-
14062-0298	125 lbs.	Command Conference Table - 8' Black	96"W x 48"D x 31"H	\$649.00		\$	-
14062-0304	125 lbs.	Command Conference Table - 8' Sirona	96"W x 48"D x 31"H	\$649.00		\$	-
14062-0301	125 lbs.	Command Conference Table - 8' White	96"W x 48"D x 31"H	\$649.00		\$	-
14062-0299	182 lbs.	Command Conference Table - 10' Black	120"W x 48"D x 31"H	\$745.00		\$	-
14062-0305	182 lbs.	Command Conference Table - 10' Sirona	120"W x 48"D x 31"H	\$745.00		\$	-
14062-0302	182 lbs.	Command Conference Table - 10' White	120"W x 48"D x 31"H	\$745.00		\$	-
<b>Office Furniture (Pg. 27 &amp; 28)</b>							
14309-0001	125 lbs.	Computer Kiosk - Black	24"Square x 42"H	\$497.00		\$	-
14179-0005	125 lbs.	Computer Kiosk - White	24"Square x 42"H	\$497.00		\$	-
14072-0108	225 lbs.	Black Credenza	60"W x 20"D x 29"H	\$446.00		\$	-
14083-0105	290 lbs.	Black Double Pedestal Desk	60"W x 30"D x 29"H	\$509.00		\$	-
14029-0098	56 lbs.	5 Shelf Bookcase - Black	36"W x 12"D x 72"H	\$478.00		\$	-
14029-0091	56 lbs.	5 Shelf Bookcase - Mahogany	36"W x 12"D x 72"H	\$478.00		\$	-
14072-0039	200 lbs.	Genoa Kneespace Credenza	66"W x 20"D x 29"H	\$446.00		\$	-
14083-0117	290 lbs.	Genoa Executive Desk	72"W x 36"D x 29"H	\$528.00		\$	-
14072-0038	225 lbs.	Genoa Storage Credenza	66"W x 20"D x 29"H	\$446.00		\$	-
05088-0365	70 lbs.	Vivid Café Table - Square	42"Square x 30"H	\$415.00		\$	-
05088-0364	90 lbs.	Vivid Café Table - Rectangle	60"W x 36"D x 30"H	\$478.00		\$	-

05088-0498	77 lbs.	Brooklyn II Rect Dining Table	60"W x 36"D x 30"H	\$497.00		\$	-
05088-0499	59 lbs.	Brooklyn II Round Dining Table	42" Round x 30"H	\$390.00		\$	-
05090-0001	90 lbs.	Aspen Dining Table	72"W x 30"D x 30"H	\$579.00		\$	-
05088-0505	200 lbs.	Brio Dining Table	96"W x 48"D x 30"H	\$777.00		\$	-
<b>Metal File &amp; Storage Cabinets (Pg. 29)</b>							
14148-0001	35 lbs.	2 Drawer Vertical File - Letter Size Black	15"W x 25"D x 29"H	\$167.00		\$	-
14147-0001	35 lbs.	2 Drawer Vertical File - Legal Size Black	18"W x 25"D x 29"H	\$217.00		\$	-
14148-0002	45 lbs.	4 Drawer Vertical File - Letter Size Black	15"W x 25"D x 52"H	\$224.00		\$	-
14147-0002	45 lbs.	4 Drawer Vertical File - Legal Size Black	18"W x 25"D x 52"H	\$249.00		\$	-
14143-0006	100 lbs.	2 Drawer Lateral File - Black	36"W x 18"D x 27"H	\$224.00		\$	-
14143-0144	125 lbs.	2 Drawer Lateral File - Black	36"W x 20"D x 29"H	\$224.00		\$	-
14143-0008	170 lbs.	4 Drawer Lateral File - Black	36"W x 18"D x 54"H	\$274.00		\$	-
14034-0015	135 lbs.	Storage Cabinet - Black	36"W x 18"D x 72"H	\$274.00		\$	-
<b>Pedestals (Pg. 30)</b>							
12091-0023	50 lbs.	Display Pedestal 14" x 42" Black	14"Square x 42"H	\$332.00		\$	-
12091-0004	120 lbs.	Display Pedestal 24" x 42" Black	24"Square x 42"H	\$402.00		\$	-
12091-0002	55 lbs.	Display Pedestal 18" x 42" Black	18"Square x 42"H	\$370.00		\$	-
12091-0030	50 lbs.	Display Pedestal 14" x 42" White	14"Square x 42"H	\$332.00		\$	-
12091-0024	45 lbs.	Display Pedestal 14" x 36" Black	14"Square x 36"H	\$281.00		\$	-
12091-0034	75 lbs.	Display Pedestal 24" x 36" Black	24"Square x 36"H	\$402.00		\$	-
12091-0031	45 lbs.	Display Pedestal 14" x 36" White	14"Square x 36"H	\$281.00		\$	-
12091-0033	75 lbs.	Display Pedestal 24" x 36" White	24"Square x 36"H	\$402.00		\$	-
12091-0025	40 lbs.	Display Pedestal 14" x 30" Black	14"Square x 30"H	\$262.00		\$	-
12091-0003	80 lbs.	Display Pedestal 24" x 30" Black	24"Square x 30"H	\$382.00		\$	-
12091-0001	45 lbs.	Display Pedestal 18" x 30" Black	18"Square x 30"H	\$269.00		\$	-
12091-0032	40 lbs.	Display Pedestal 14" x 30" White	14"Square x 30"H	\$262.00		\$	-
14309-0001	125 lbs.	Locking Pedestal Black	24"Square x 42"H	\$497.00		\$	-
14179-0005	125 lbs.	Locking Pedestal White	24"Square x 42"H	\$497.00		\$	-
12091-0055	24 lbs.	Fuze Pedestal	16"Square x 44"H	\$274.00		\$	-
12091-0043	24 lbs.	London Pedestal	16"Square x 44"H	\$274.00		\$	-
<b>Miscellaneous Items (Pg. 31)</b>							
14189-0066	30 lbs.	Stanchion Chrome	41"H	\$77.00		\$	-
11526-0001	2 lbs.	Stanchion Rope - Red Velour	6' L	\$40.00		\$	-
14308-0009	8 lbs.	Nero Literature Stand - Black	15"W x 12"D x 53.5"H	\$186.00		\$	-
14308-0010	8 lbs.	Argento Literature Rack	15"W x 12"D x 53.5"H	\$186.00		\$	-
14308-0005	7 lbs.	Alto Literature Rack	10.5"W x 9.5"D x 57"H	\$192.00		\$	-
01209-0003	50 lbs.	Compact Refrigerator Black - 4.0 Cu Ft	21"W x 22"D x 32"H	\$345.00		\$	-
<b>Lighting (Pg. 31)</b>							
09392-0019	15 lbs.	Silo Grey Floor Lamp	70"H	\$169.00		\$	-
09417-0037	7 lbs.	Silo Grey Table Lamp	25"H	\$123.00		\$	-
09392-0018	15 lbs.	Silo White Floor Lamp	70"H	\$169.00		\$	-
09417-0036	7 lbs.	Silo White Table Lamp	25"H	\$123.00		\$	-
09392-0001	7 lbs.	Neutrino Steel Floor Lamp - Steel	67"H	\$173.00		\$	-





**DO NOT MAIL ORDER FORM - Email / Fax Form ONLY**

Please make payments payable to: American Furniture Rentals, Inc.  
 PO BOX 778962  
 Chicago, IL 60677-8962

<b>Total Product</b>	\$	-
<b>Late Fee %</b>	\$	-
<b>Sub Total</b>	\$	-
<b>Sales Tax %</b>	10.25%	\$ -
<b>Total Amount Due</b>	\$	-

<b>Company Name</b>	-	<b>Credit Card Type</b>	
<b>Street Address</b>		<b>Credit Card #</b>	
<b>City</b>		<b>Card Holder</b>	
<b>State</b>		<b>Expiration Date</b>	<b>Security Code</b>
<b>Zip Code</b>		<b>Signature</b>	
<b>Name / Date of Show</b>		<b>Date</b>	
<b>Booth Number</b>	-	<b>Email Address</b>	
<b>Contact Name</b>		<b>Fax #</b>	
<b>Contact Cell</b>			
<b>Special Instructions:</b>			